

**COMBI 206 WH / 3xWAGO 221-413**

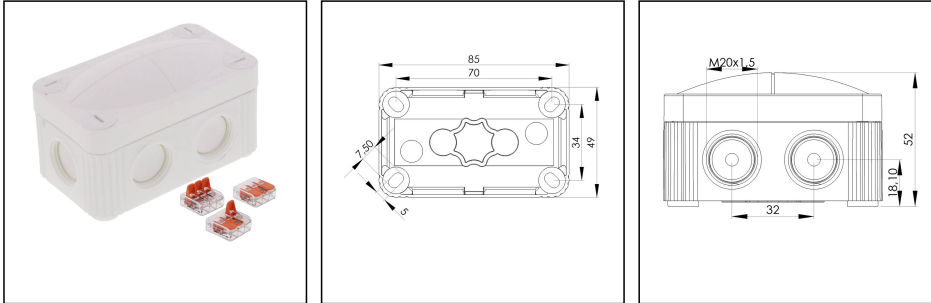

Products may differ in size, colour and appearance to those shown. If you require further information or customisation, please contact us directly.



<b>Material</b>	Polypropylene
<b>Material sealing gasket</b>	TPE
<b>Temp. range min</b>	-30 °C
<b>Temp. range max</b>	100 °C
<b>Temperatures during install.</b>	-5 °C - 60 °C
<b>Protection class</b>	IP66 / IP67
<b>Glow wire test</b>	750 °C
<b>Voltage</b>	400 V
<b>Rated cross section</b>	1,5 mm <sup>2</sup>
<b>Terminals/poles</b>	4 mm <sup>2</sup>
<b>Fixing</b>	4 internal openings
<b>Ø cable diameter min</b>	3 mm
<b>Ø cable diameter max</b>	12 mm
<b>External dimensions LxWxH</b>	85 x 49 x 51mm
<b>Using for cable gland</b>	
<b>Product Color</b>	RAL 9001
<b>Order no. RAL 9001</b>	10109902
<b>Type</b>	COMBI 206 WH / 3xWAGO 221-413
<b>Packing unit</b>	10
<b>EAN number</b>	4007686103250
<b>Tariff number</b>	85369010
<b>ETIM-Classification</b>	EC002600

Remarks:

IP66: using the membrane entry

Your Contact:

**WISKA UK Ltd.**

Unit 7, Hurling Way · St. Columb Major Business Park · TR9 6SX, St. Columb Major, Cornwall · Great Britain

☎ +44-12-08816062 · 📠 +44-12-08816708

info@wiska.co.uk · www.wiska.co.uk

**IP67: using the threaded entry together with ESKV cable gland**

**Equipment:**

- 6 M20 threaded membrane entries
- 2 membrane cable entries through rear
- 4 captive cover screws
- including 3x WAGO 221-413 enclosed loose

**Fixing:**

**With 4 internal openings outside of the sealing area**

**Recommended accessories**

<b>MP-S Mounting plate small</b>	10105774
<b>ZER 4-12 LG</b>	10109800

18.10.2023

Your Contact:

**WISKA UK Ltd.**

Unit 7, Hurling Way · St. Columb Major Business Park · TR9 6SX, St. Columb Major, Cornwall · Great Britain

☎ +44-12-08816062 · 📠 +44-12-08816708

info@wiska.co.uk · www.wiska.co.uk

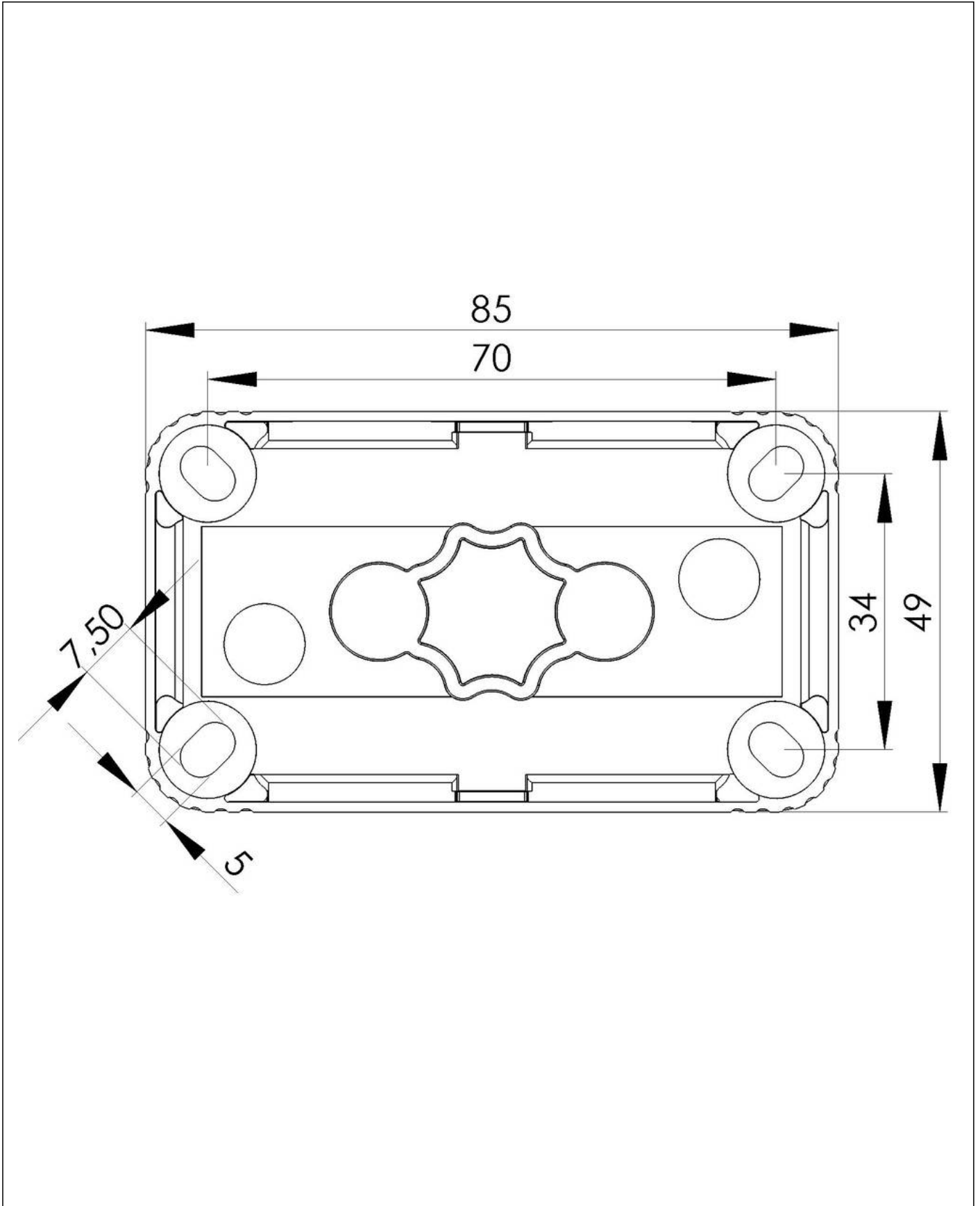

Your Contact:

**WISKA UK Ltd.**

Unit 7, Hurling Way · St. Columb Major Business Park · TR9 6SX, St. Columb Major, Cornwall · Great Britain

☎ +44-12-08816062 · 📠 +44-12-08816708

info@wiska.co.uk · www.wiska.co.uk

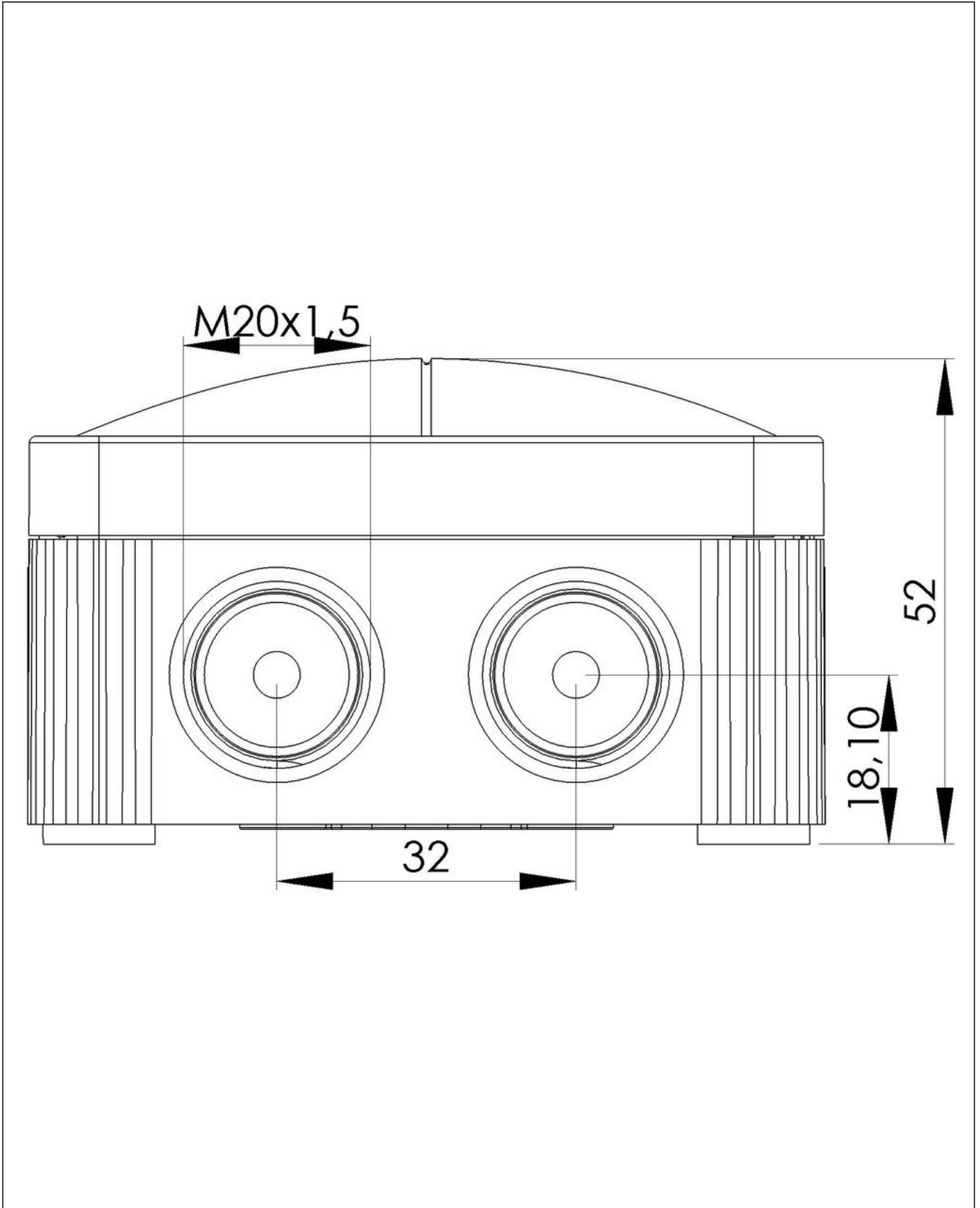

Your Contact:

**WISKA UK Ltd.**

Unit 7, Hurling Way · St. Columb Major Business Park · TR9 6SX, St. Columb Major, Cornwall · Great Britain

☎ +44-12-08816062 · 📠 +44-12-08816708

info@wiska.co.uk · www.wiska.co.uk