

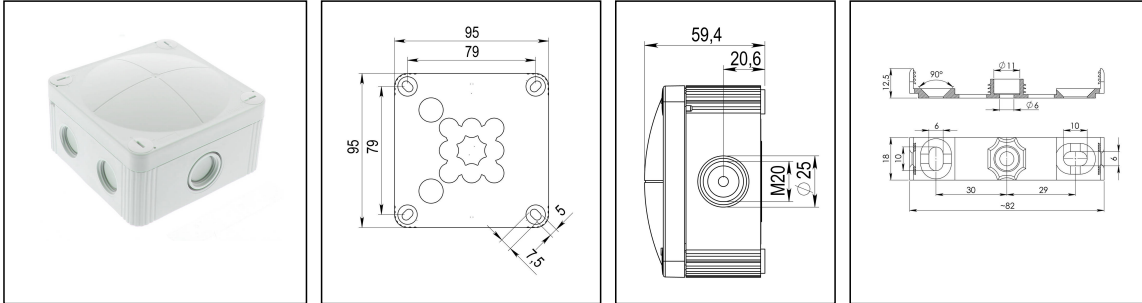

COMBI 407 LG

Junction box, polypropylene



Products may differ in size, colour and appearance to those shown. If you require further information or customisation, please contact us directly.



Material	Polypropylene
Material sealing gasket	TPE
Temp. range min	-30 °C
Temp. range max	100 °C
Temperatures during install.	-5 °C - 60 °C
Protection class	IP66 / IP67
Glow wire test	750 °C
Voltage	690 V
Rated cross section	4 mm ²
Fixing	4 internal openings
Ø cable diameter min	3 mm
Ø cable diameter max	12 mm
External dimensions LxWxH	95 x 95 x 60mm
Type of cable gland	M 20 x 1,5, M 25 x 1,5
Using for cable gland	
Product Color	RAL 7035
WISKA-Order no.	10105595
Type	COMBI 407 LG
Packing unit	5
EAN number	4007686010794
Tariff number	39269097
ETIM-Classification	EC002600

Remarks:

IP66: using the membrane entry

Your Contact:

WISKA UK Ltd.

Unit 7, Hurling Way · St. Columb Major Business Park · TR9 6SX, St. Columb Major, Cornwall · Great Britain

☎ +44-12-08816062 · 📠 +44-12-08816708

info@wiska.co.uk · www.wiska.co.uk

IP67: using the threaded entry together with ESKV cable gland

Equipment:

- 6x M20 threaded membrane entries and 1 middle M20 threaded membrane entry with knockout to M25
- 2 membrane cable entries through rear
- 4 captive cover screws
- including mounting clip

Fixing:

With mounting clip or 4 internal openings outside of the sealing area

Recommended accessories

DIN Rail Kit - COMBI 407/TS 15	10105604
DIN Rail Kit - COMBI 407/TS 35	10105605
MP-S Mounting plate small	10105774
MP-L Mounting plate large COMBI / WHK	10105775
External mounting - COMBI LG	10108836
ZER 4-12 LG	10109800
SP-KT-W 221/CSM-3x221-413	22001114
SP-KT-W 221/CSM	22001115
SP-HKT 11/5 Terminal block	22001132

17.10.2023

Your Contact:

WISKA UK Ltd.

Unit 7, Hurling Way · St. Columb Major Business Park · TR9 6SX, St. Columb Major, Cornwall · Great Britain

☎ +44-12-08816062 · 📠 +44-12-08816708

info@wiska.co.uk · www.wiska.co.uk



Your Contact:

WISKA UK Ltd.

Unit 7, Hurling Way · St. Columb Major Business Park · TR9 6SX, St. Columb Major, Cornwall · Great Britain

☎ +44-12-08816062 · 📠 +44-12-08816708

info@wiska.co.uk · www.wiska.co.uk



Your Contact:

WISKA UK Ltd.

Unit 7, Hurling Way · St. Columb Major Business Park · TR9 6SX, St. Columb Major, Cornwall · Great Britain

☎ +44-12-08816062 · 📠 +44-12-08816708

info@wiska.co.uk · www.wiska.co.uk