

Catalogue

Wiring Accessories

Our stylish range of wiring accessories covers sockets & switches for any application, as well as our range of popular junction boxes & ceiling accessories.

:hager



Sollysta
White Moulded
Page 14

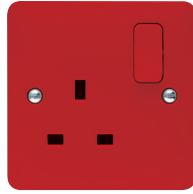

Sollysta
For Specific Equipment
Page 27



Sollysta
Part M
Page 26



Sollysta
Grid
Page 23



Sollysta Decorative
Raised Plate Options
Page 28



Sollysta Decorative
Flat Plate Options
Page 29



Sollysta Decorative
Brushed Steel
Page 28



Sollysta Decorative
Polished Steel
Page 28



Sollysta Decorative
Grid
Page 46



Sollysta Metalclad
Grey
Page 48



Sollysta IP66
Sockets
Page 54



Sollysta IP66
Switches
Page 54



Junction
Boxes
Page 55



Ceiling
Accessories
Page 56





Sollysta

Wiring Accessories

Sollysta offers a complete range of wiring solutions for any application with our White Moulded, Decorative, Grid, IP66 and Metaclad ranges.

Specifically designed to inspire confidence, the modern design combines stylish aesthetics and quality without compromising on functionality, reliability or safety.

All of the hallmark features run consistently throughout the range, including the unique neutral loop terminal on the switch and the patented three pin shutter mechanism on the sockets for additional safety. Moulded cable lead-ins, captive and backed off terminal screws, wire end stops and in-line terminals have all been designed to ease installation, saving time on site.

Sollysta Twin Socket USB A+C

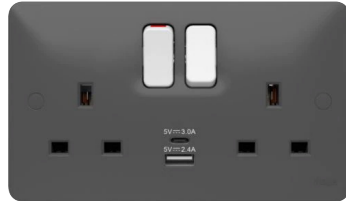

Moulded

See pages 16 & 26



Decorative

See page 32



Metalclad

See page 49



Technical characteristics - USB Charging Ports

Number of Ports	2
Intelligent Connection	Yes
USB Output Power	15.5W
USB Output Voltage	5.0 V d.c.
Standby Power Consumption	≤0.15W
Overload Protection on Output	2.8±0.3A

Technical characteristics - Socket

Standard	BS 1363-2
Voltage Rating	220-240V a.c.
Current Rating	13A per Socket Outlet
Terminal Capacity	3 x 2.5mm ² 3 x 4.0mm ² 2 x 6.0mm ²
Earth	Twin Earth
Switching	Double Pole Switching Mechanism

The latest addition to the range includes a twin port USB-A+C, providing a total maximum of 3.1A charging capacity at 5V d.c.

Our intelligent connection ensures optimum charging performance. The dual USB adapter communicates with the USB device identification circuitry. This allows the USB socket to identify itself as a dedicated charger for the connected USB devices.

The twin socket itself is in common with all Sollysta switched sockets, double pole in construction. A double pole socket switches both the live and the neutral conductors to ensure safe isolation of the plugged in appliance.

In addition the socket features the Sollysta patented 3 pin safety shutter system.



Product Features

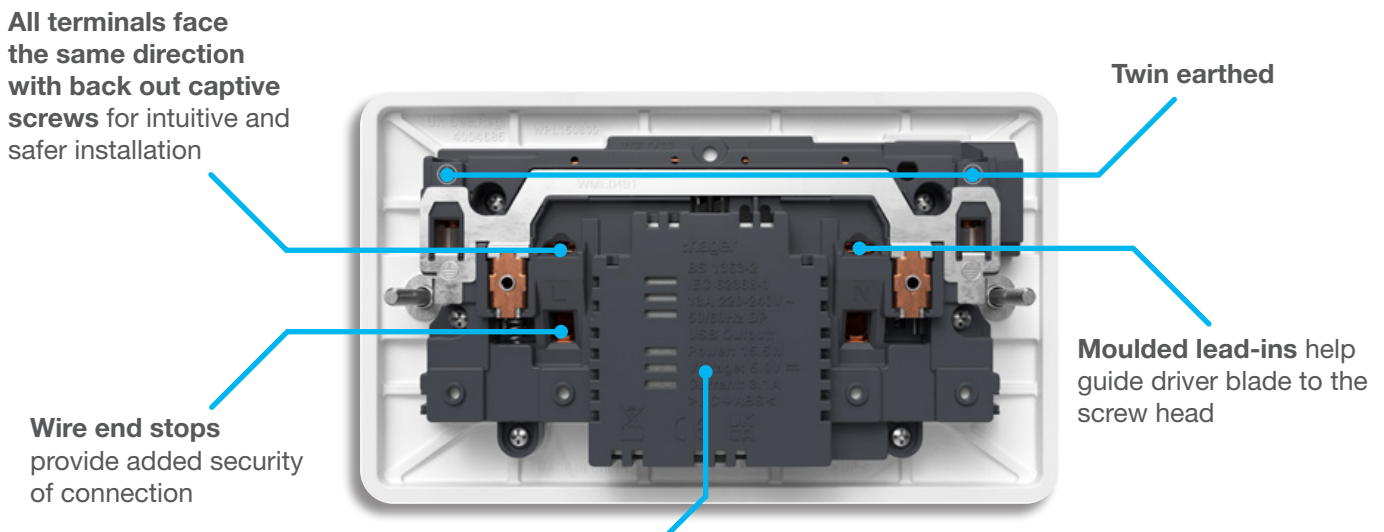
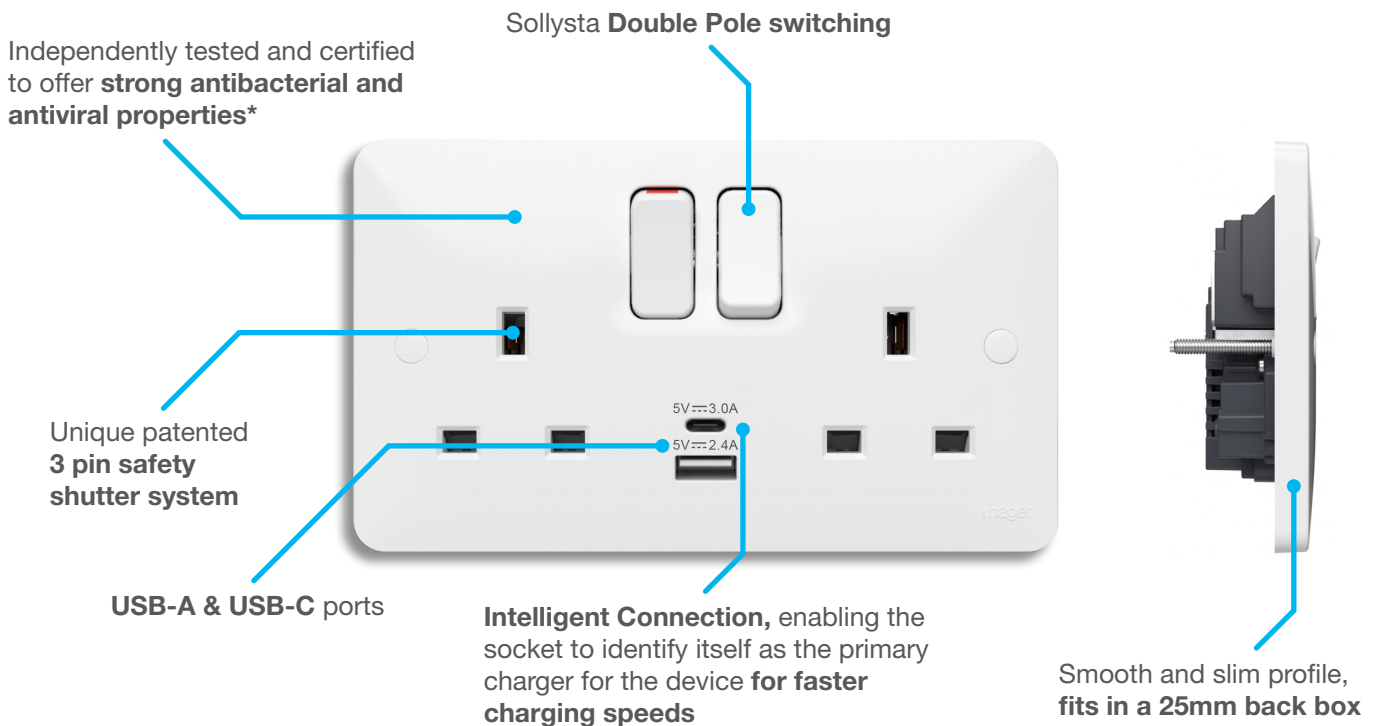

Tested by Nemko UK to all relevant clauses of **BS 1363-2:2016 + Annex** and deemed to comply

* only applicable to Moulded products



Sollysta Neutral Loop Terminal

For many years domestic lighting circuits have been connected using the three plate method where the loop terminal is at the ceiling rose.

Today, it is increasingly likely that there is a decorative light fitting or even downlighters fitted in place of a standard pendant. These fittings are rarely provided with a neutral loop terminal.

It has also become popular to make the loop connection at the switch. This has the advantage of the connections being accessible and at a more convenient working height.

However, this leaves the problem of terminating the neutral conductor.

One solution is to connect the neutral to a connector block inside the wall box, which takes up extra space.

Our solution is the Sollysta light switch which has a unique neutral loop terminal, built in.



loop terminal

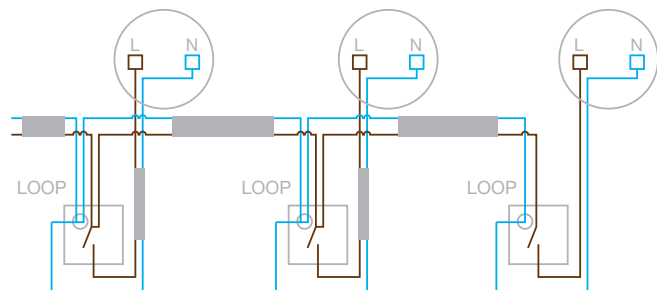

As can be seen from the diagram the neutrals are looped through the switches with a single line and neutral to each light fitting.

One of the fundamental requirements of the BS 7671 Wiring Regulations is to provide basic protection against electric shock.

Socket outlets have apertures for plug pins and therefore will have a shutter mechanism that prevents access to live parts unless the earth pin is also present and has been inserted first. This however can be either intentionally or inadvertently defeated by inserting something into the earth pin aperture.

Sollysta sockets have a unique patented shutter system that not only requires the earth pin to be inserted first, but the simultaneous insertion of the live and neutral pins as well, before the shutter mechanism is activated.

This enhances safety by making it difficult to defeat the mechanism and therefore reducing the risk of electric shock.

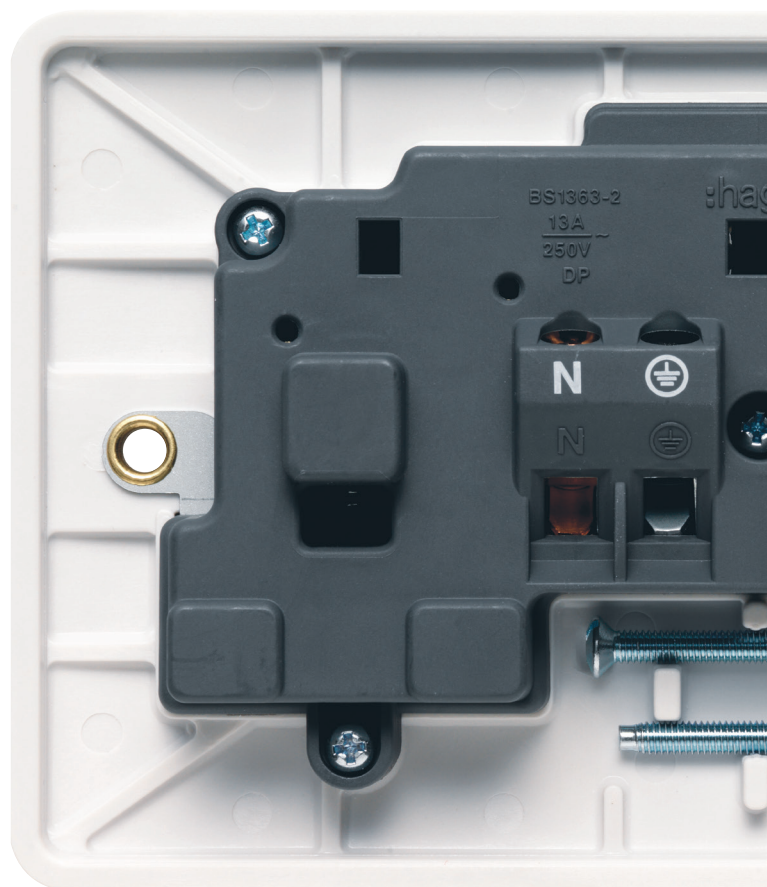
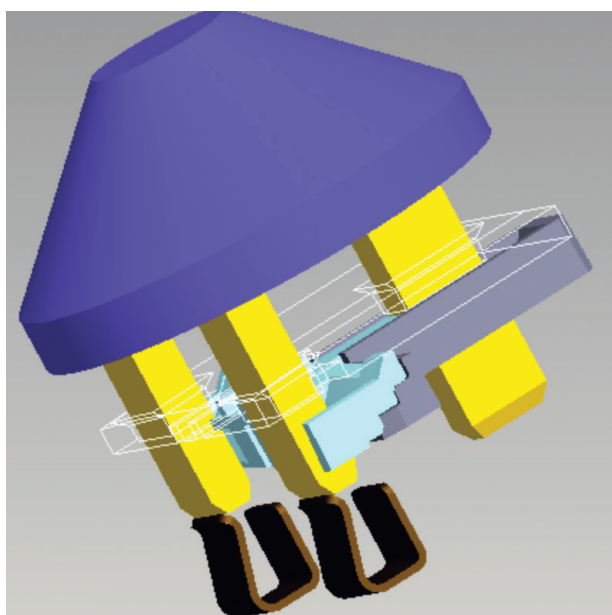
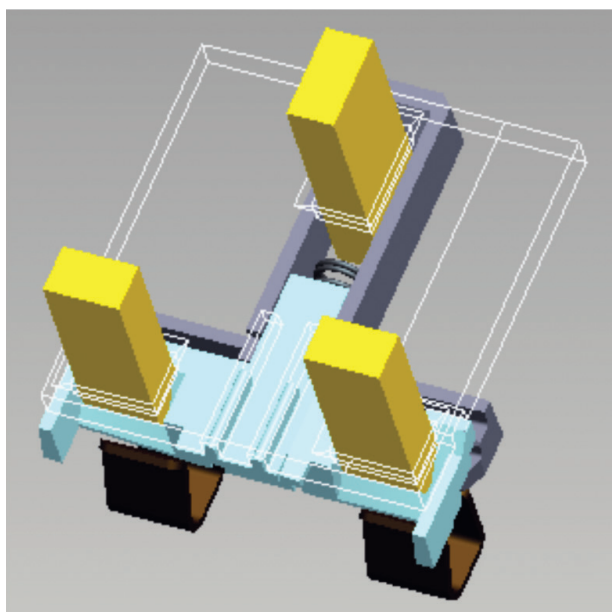

Unique Safety Shutters

Sollysta

Wiring Accessories

In addition to the aesthetics for the home owner and specifier, Sollysta has been designed to make the installation easier for the installer. Terminals designed to face in the same direction with lead-ins for wiring, backed out screws held captive to prevent loss, wire end stops and clear identification all help make the wiring and cabling much easier, helping to save time on site.

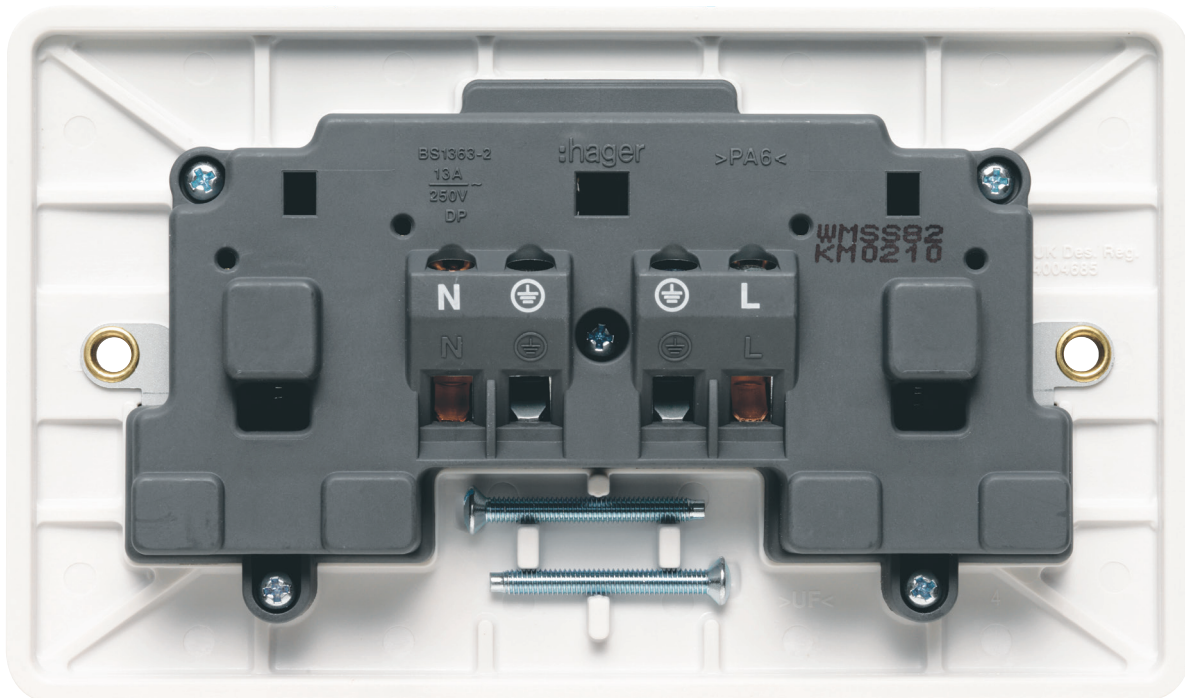

01

Terminals

The terminals all face in the same direction, removing the need to rotate the product during installation.



02 Terminal Screws

Terminal screws are supplied in the backed out position to save installation time and are also held captive within the moulding so they won't be lost.



03 Lead-ins

Moulded lead-ins help to guide the driver blade to the screw head.



04 Wire End Stops

A positive wire end stop provides added security of connection.

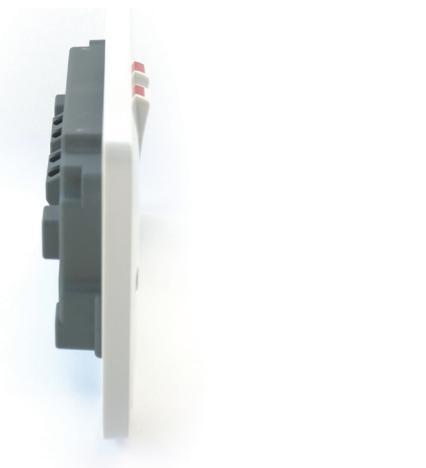

05 Projection

The range has been designed to offer the shallowest projection possible in the back box, maximising space for cabling.

Maintenance Free Junction Box

See page 55

The Maintenance Free Junction Box provides a secure and maintenance free means of connecting fixed wiring in any indoor application, whether it be under floor applications, between ground and first floor in houses, or where the jointing of cables is used to aid rewiring.

BS 7671 (Wiring Regulations) recognises equipment complying with an appropriate British Standard without further qualification. Therefore, a junction box marked (MF) is identified as a maintenance free accessory, which does not require further inspection, testing or maintenance after installation in a circuit.

The terminals accept and secure solid, stranded or flexible conductors from 0.5mm² to 4mm². Twin and CPC and flexible cords can all be mixed. You then secure the cage clamp terminal using a screwdriver or finger to push down on the push button.

The Maintenance Free junction box is ideal for use in residential and commercial buildings, refurbishments and re-wires, power and lighting circuits and circuits wired in sheathed cables.

The Maintenance Free junction box is unrivalled in today's market. No other junction box provides as many features that allow contractors to comply with the latest wiring regulations.



Screwless Terminations

Tests on these terminals include long-term vibration, shock test, long term connection test, pull out, voltage drop, temperature rise and exposure to corrosive atmospheres



Cable clamps

Cable clamps prevent strain on terminations and prevent exposed unsheathed conductors.



Breakout

The simple breakouts on the base and lid allow you to select your cable entry points.

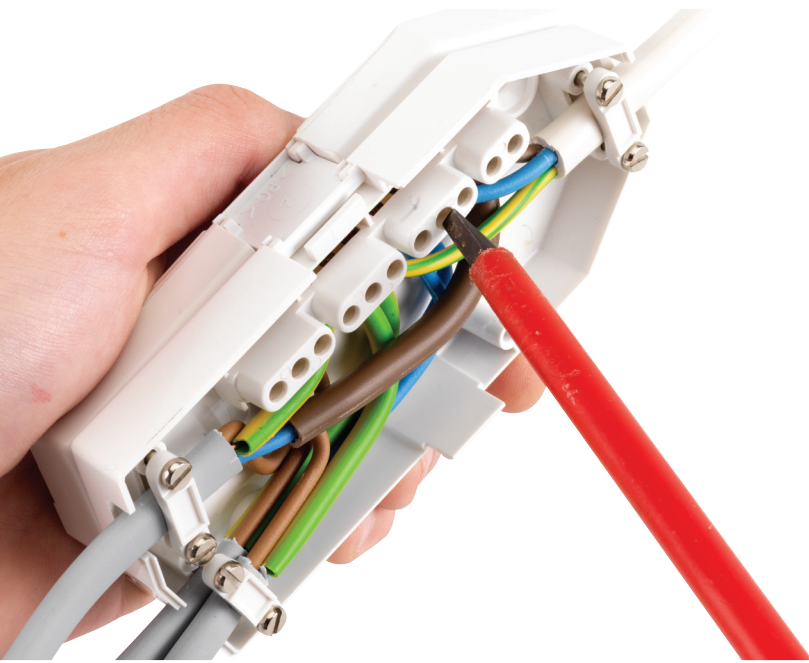

Recognising that junction boxes are used to supply the connection between fixed wiring and downlighters, we developed a junction box that will help contractors meet the needs of the regulations.

Downlighter Junction Box

See page 55

The J501 is torpedo shaped to fit through a 58mm diameter hole in the ceiling. All the cables are securely clamped and they exit from either end of the junction box. This is in contrast to other junction boxes where the cables are generally not clamped and often exit at different angles, making it hard to push or pull them through the hole without risking damage or loosening the connections.

A loose or disconnected cable is a hidden danger with junction boxes. With an increasing drive for safety, such products have come under close inspection.

Wiring is fast and simple. The J501 fits comfortably in the hand and the cables can be clamped for easier connection. Cabling space is maximised with all the terminals arranged on one side and the upper wall on the lid hinges open 360° for unrestricted access.

For wiring, the three plate terminal style in the box is logical and easy to use and separate terminals for flexible cords and twin and CPC cables help prevent damage to smaller flexible conductors.

During installation all the cables are securely clamped, so there is no strain placed on the terminal connections and no risk of exposed unsheathed conductors. The cable clamps can be reversed to allow either single or double cable entry, which allows up to four flat and one flexible cable to be terminated.

Safety Pendants & Lampholders

See page 56



- 01 Lampholder & Skirt
- 02 Ceiling Rose Cover
- 03 Terminal Safety Cover
- 04 Terminal Plate

Our philosophy is to provide all of our pendants and lampholders with a safety J-slot mechanism which automatically disconnects power at the contacts when the lamp is removed.

This prevents electric shock due to accidental touching of the contacts when changing or installing lamps.

This applies to

Safety Bayonet Cap Cord Grip Lampholders

Safety Straight Batten Lampholders

Safety Access Batten Lampholders

Safety Pendant Sets with Access Ceiling Rose



Safety Terminal Cover clips onto Terminal Plate enclosing live parts.

Additional safety can be achieved with our terminal cover which provides protection against accidental contact with electrical connections.

Safety is ensured with the clipable cover which shrouds all electrical connections whilst allowing removal of the ceiling rose cover for decorating or maintenance.

Safety Pendant & Batten Lampholder with Terminal Safety Cover



Safety Lampholders Complete with Safety Covers

Pendant Set 6" with Safety Cover

Batten Lampholder with Safety Cover

Wiring Accessories

Our expansive range of Sollysta Wiring Accessories have been designed from the beginning to be installer friendly, tactile & safe.

Connect cables and install lamps securely with our Ceiling Accessories and Junction Boxes.



Sollysta

White Moulded	14
---------------	----

Decorative	28
------------	----

Metalclad	48
-----------	----

IP66	54
------	----

Junction Boxes

Maintenance Free Junction Boxes	55
---------------------------------	----

Downlighter Junction Boxes	55
----------------------------	----

Traditional Junction Boxes	55
----------------------------	----

Ceiling Accessories

Safety Lampholders	56
--------------------	----

Safety Pendants	56
-----------------	----

Technical Pages	58
-----------------	----



WMPS11



WMPS12W



WMPS262



WMPS12RB

Wall Switches

Characteristics:

- Unique patented loop terminal allows neutral looping at the switch.
- Complies with BS EN 60669-1:2018, a.c only.
- 'X' rated - No need to derate for fluorescent loads.
- Clear terminal markings: 1-way L1, 2-way L2
- Capacity of each terminal - 2 x 4.0mm² conductors.
- For mounting boxes see selection chart on page 58.
- For multigang switches use of a 25mm mounting box will provide increased wiring space.
- Supplied with M3.5 x 20mm long fixing screws and screw covers.
- Suitable for SBL circuits to a maximum of 100 W SBL

10AX Wall Switches

Description	Cat ref.
1 Gang 1 Way	WMPS11
1 Gang 1 Way Printed 'Fan'	WMPS11/FAN
1 Gang 2 Way	WMPS12
2 Gang 2 Way	WMPS22
3 Gang 2 Way	WMPS32
4 Gang 2 Way	WMPS42
6 Gang 2 Way	WMPS62
1 Gang 2 Way Wide Rocker	WMPS12W
2 Gang 2 Way Wide Rocker	WMPS22W

Intermediate Switches

Description	Cat ref.
Intermediate Switch	WMPS16
10AX 2 Gang 2 Way & Intermediate Wall Switch	WMPS262

Push Switches

Description	Cat ref.
Push Switches	
Retractive Switch	WMPS12R
With Bell Symbol	WMPS12RB
With Wide Rocker	WMPS12RW

Dimmer Plate Kits

Characteristics:

- Suitable for most D shaft push and rotary dimmer switch modules
- Maintains Sollysta aesthetic for a wide range of manufacturers switches
- Plate and matching button(s) supplied
- Supplied with M3.5 x 30mm long fixing screws and screw covers.

Description

1 Gang Rotary Dimmer Switch Plate Kit
2 Gang Rotary Dimmer Switch Plate Kit
3 Gang Rotary Dimmer Switch Plate Kit
4 Gang Rotary Dimmer Switch Plate Kit

Cat ref.

WMDRP1KIT
WMDRP2KIT
WMDRP3KIT
WMDRP4KIT



WMDRP1KIT
(Each kit comes with matching button(s))

Rotary Push Button Dimmer Switches

Characteristics:

- Quick press for on/off with rotary dimming control.
- 1 or 2 way switching.
- Supplied with M3.5 x 30mm long fixing screws and screw covers.
- Complies with BS EN 60669-2-1 (excluding clause 26 EMC requirements).

Mains Halogen

- Suitable for mains halogen lamps without the need for derating.
- Not suitable for fluorescent, LED or inductive loads.

LED

- Leading edge functionality compatible with many dimmable LED lamps & fittings
- Thermal safety fuse for short circuit protection



WMDR1

Description

Rotary Push Button Dimmer Switches (LED)

1 Gang 400W
2 Gang 250W

Cat ref.

WMDR1L
WMDR2L

Resistive Load for LED Applications

WMRESLOAD

Isolator Switches

Characteristics:

- Complies with BS EN 60669-2-4
- Rated conditional short circuit current (I_{nc}) 1500A tested with Hager **MTN110** 6kA B curve MCB.
- Capacity of each terminal 2 x 4.0mm² conductors.
- For mounting boxes see selection chart on page 58.
- Supplied with M3.5 x 20mm long fixing screws and screw covers.

Description

3 Pole Isolator Switches

Isolator Switch
Isolator Switch with Fan Symbol

Cat ref.

WMPS3PI
WMPS3PIF



WMPS3PIF



WMSS82



WMS51



WMSS82-USBAC



WMS812LN

Switched & Unswitched Socket Outlets

Characteristics:

- Unique patented three part safety shutter.
- Complies with BS 1363-2, a.c only.
- Double pole switching mechanism on switched sockets.
- Twin socket comes with twin earth as standard.
- All terminal screws grouped in-line and upward facing for ease of installation.
- Clear printed and engraved terminal markings.
- Capacity of each terminal: 3 x 4mm² conductors switched & unswitched (for other sized conductors see terminal capacities on page 59).
- **Sockets with USB connections - Warning:** To avoid possible damage to the product or spurious insulation readings, please disconnect the product before carrying out insulation resistance testing.
- **Sockets with USB connections:** USB output: 5V d.c. 3.1A total max.
- For mounting boxes see selection chart on page 58.
- Supplied with M3.5 x 30mm long fixing screws and screw covers.

Description

Switched Socket Outlets

Description	Cat ref.
13A 1 Gang Double Pole	WMSS81
13A 2 Gang Double Pole Dual Earth	WMSS82
13A 2 Gang Double Pole Dual Earth & Two USB Ports (Type A+A)	WMSS82USB
13A 2 Gang Double Pole Dual Earth & Two USB Ports (Type A +C)	WMSS82-USBAC
10mm Spacer for 2 Gang Sockets	WMUSBS
13A 2 Gang Double Pole Dual Earth Outboard Rockers	WMSS82O
13A 1 Gang Double Pole with LED Indicator	WMSS81N
13A 2 Gang Double Pole Dual Earth with LED Indicator	WMSS82N
13A 2 Gang Double Pole Dual Earth Outboard Rockers & LED Indicator	WMSS82ON
15A 1 Gang	WMSS115

Key Switch Sockets

13A Double Pole Key Switch Socket with LED Indicator	WMS812LN
--	-----------------

Unswitched Socket Outlets

5A 1 Gang	WMS51
13A 1 Gang	WMS81
13A 2 Gang Dual Earth	WMS82

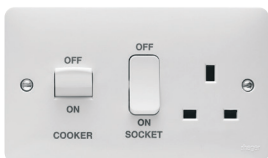

WMCC50

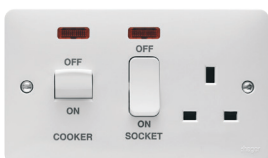

WMCC50N

Cooker Control Unit

Characteristics:

- Complies with BS 4177.
- Switch and socket are double pole.
- Twin earth as standard.
- Main switch is suitable for isolation.
- All terminals are upward facing for ease of installation.
- Clearly printed terminal marking.
- Capacity of terminals: 2 x 6.0mm², 1 x 16.0mm².
- For mounting boxes see selection chart on page 58.
- Supplied with M3.5 x 30mm long fixing screws and screw covers.

Description

Description	Cat ref.
45A Cooker Control Unit	WMCC50
45A Cooker Control Unit with LED Indicator	WMCC50N

Outlet Plates

Characteristics:

- Complies with BS 5733
- Terminal capacity: 20A 2 x 6.0mm², 45A 2 x 10.0mm² conductors
- 20A plate features 2 separate terminals for each of Line, Neutral and Earth so flexible and fixed wiring do not occupy the same terminal.
- Single screw fast fix cable clamp.
- Supplied with M3.5 x 30mm long fixing screws and screw covers.
- 45A features large open brass terminals for ease of installation.
- Protective red washer must be used under cable clamp to prevent damage to cable.



WMP2FO

Description

Description	Cat ref.
Outlet Plates	
20A Flex Outlet Plate	WMP2FO
45A Cooker Cable Outlet with Terminals	WMP50FO

Switched & Unswitched Fused Connection Units (13A)

Characteristics:

- Complies with BS 1363-4.
- Single screw fast fix cable clamp, accommodates up to 2.5mm² flexible cord.
- All terminals are upward facing with clearly printed terminal markings for ease of installation.
- Capacity of each terminal 2 x 6.0mm² conductors.
- Supplied with M3.5 x 30mm long fixing screws and screw covers.
- For mounting boxes see selection chart on page 58.
- We also offer a bespoke printing service for your individual requirements. Please contact our Estimation Team on 01952 675594 for further details.

Note: For constant 3kW loads not requiring overload protection, consideration should be given to the use of 20A DP switches instead (page 18).

Description	Cat ref.
13A Switched Fused Connection Units	
FCU	WMSSU83
FCU With Flex Outlet	WMSSU83FO
FCU With LED Indicator	WMSSU83N
FCU With LED Indicator & Flex Outlet	WMSSU83FON
FCU With 3A Fuse	WMSSU83/3A
13A Unswitched Fused Connection Units	
FCU	WMSU83
With Flex Outlet	WMSU83FO
13A Unswitched Fused Connection Units - Printed Text	
Printed - 'Plinth Heater'	WMSU83PH
Printed - 'Storage Heater'	WMSU83SH
13A Switched Fused Connection Units - Printed Text	
Printed 'Boiler'	WMSSU83/BO
Printed 'Central Heating'	WMSSU83/CTLHTG
Printed 'Dishwasher'	WMSSU83/DW
Printed 'Extract Fan'	WMSSU83/EF
Printed 'Fan'	WMSSU83/FAN
Printed 'Fridge Freezer'	WMSSU83/FF
Printed 'Freezer'	WMSSU83/FRE
Printed 'Fridge'	WMSSU83/FRI
Printed 'Heating'	WMSSU83/HTG
Printed 'Heater'	WMSSU83/HTR
Printed 'Shower Pump'	WMSSU83/SHWRPUMP
Printed 'Socket Below'	WMSSU83/SKTBELOW
Printed 'Tumble Dryer'	WMSSU83/TD
Printed 'Washing Machine'	WMSSU83/WM
13A Switched Fused Connection Units with Flex Outlet - Printed Text	
Printed 'Boiler'	WMSSU83FO/BO
Printed 'Dishwasher'	WMSSU83FO/DW
Printed 'Extractor Fan'	WMSSU83FO/EF
Printed 'Fridge Freezer'	WMSSU83FO/FF
Printed 'Freezer'	WMSSU83FO/FRE
Printed 'Fridge'	WMSSU83FO/FRI
Printed 'Heating'	WMSSU83FO/HTG
Printed 'Heater'	WMSSU83FO/HTR
Printed 'Tumble Dryer'	WMSSU83FO/TD
Printed 'Washing Machine'	WMSSU83FO/WM



WMSSU83



WMSSU83N



WMSU83FO



WMSSU83-DW



WMSSU83FO/FF

Continued overleaf



WMSSU83N/HB



WMSSU83FON/BO



WMDP84FON

Unswitched & Switched Fused Connection Units (13A) - Continued

Description	Cat ref.
13A Switched Fused Connection Units with LED Indicator - Printed Text	
Printed 'Boiler'	WMSSU83N/BO
Printed 'Dishwasher'	WMSSU83N/DW
Printed 'Extractor Fan'	WMSSU83N/EF
Printed 'Fan'	WMSSU83N/FAN
Printed 'Freezer'	WMSSU83N/FRE
Printed 'Fridge'	WMSSU83N/FRI
Printed 'Hob'	WMSSU83N/HB
Printed 'Heating'	WMSSU83N/HTG
Printed 'Tumble Dryer'	WMSSU83N/TD
Printed 'Washing Machine'	WMSSU83N/WM

13A Switched Fused Connection Units with LED Indicator & Flex Outlet - Printed Text	
Printed 'Boiler'	WMSSU83FON/BO
Printed 'Dishwasher'	WMSSU83FON/DW
Printed 'Extractor Fan'	WMSSU83FON/EF
Printed 'Fan'	WMSSU83FON/FAN
Printed 'Freezer'	WMSSU83FON/FRE
Printed 'Fridge'	WMSSU83FON/FRI
Printed 'Hob'	WMSSU83FON/HB
Printed 'Heating'	WMSSU83FON/HTG
Printed 'Tumble Dryer'	WMSSU83FON/TD
Printed 'Washing Machine'	WMSSU83FON/WM

Double Pole Switches (20A)

Characteristics:

- Complies with BS EN 60669-1, a.c. only.
- Single screw fast fix cable clamp, accommodates up to 2.5mm² flexible cord.
- All terminals are upward facing with clearly printed terminal markings for ease of installation.
- Capacity of each terminal 2 x 6.0mm² conductors.
- For mounting boxes see selection chart on page 58.
- Supplied with M3.5 x 30mm long fixing screws and screw covers.
- We also offer a bespoke printing service for your individual requirements. Please contact our Estimation Team on 01952 675594 for further details.

Description	Cat ref.
20A Double Pole Switches	
20A Double Pole Switch	WMDP84
With Flex Outlet	WMDP84FO
With LED Indicator	WMDP84N
With LED Indicator & Flex Outlet	WMDP84FON

20A Double Pole Switches - Printed Text	
Printed 'Dishwasher'	WMDP84/DW
Printed 'Freezer'	WMDP84/FRE
Printed 'Fridge'	WMDP84/FRI
Printed 'Tumble Dryer'	WMDP84/TD
Printed 'Washing Machine'	WMDP84/WM

20A Double Pole Switches with Flex Outlet - Printed Text	
Printed 'Freezer'	WMDP84FO/FRE
Printed 'Fridge'	WMDP84FO/FRI

20A Double Pole Switches with LED Indicator & Flex Outlet - Printed Text	
Printed 'Dishwasher'	WMDP84FON/DW
Printed 'Fan'	WMDP84FON/FAN
Printed 'Freezer'	WMDP84FON/FRE
Printed 'Fridge'	WMDP84FON/FRI
Printed 'Tumble Dryer'	WMDP84FON/TD
Printed 'Washing Machine'	WMDP84FON/WM
Printed 'Waterheater'	WMDP85FON

Double Pole Switches (20A) (Continued)

20A Double Pole Switches with LED Indicator - Printed Text

Printed 'Dishwasher'	WMDP84N/DW
Printed 'Fan'	WMDP84N/FAN
Printed 'Freezer'	WMDP84N/FRE
Printed 'Fridge'	WMDP84N/FRI
Printed 'Tumble Dryer'	WMDP84N/TD
Printed 'Washing Machine'	WMDP84N/WM
Printed 'Waterheater'	WMDP85N



WMDP85N

Double Pole Switches (20A) with Isolator Function

Characteristics:

- Complies with BS EN 60669-2-4.
- Rated conditional short circuit current (I_{nc}) 1500A tested with Hager MTN150 6kA B curve MCB.
- All terminals are upward facing with clearly printed terminal markings for ease of installation.
- Capacity of each terminal 2 x 6mm², 1 x 10mm².
- For mounting boxes see selection chart on page 58.
- WM & WR references supplied with M3.5 x 30mm long fixing screws.
- WF references supplied with M3.5 x 20mm long fixing screws.

Description	Cat ref.
20A Double Pole Switches with Isolator Function	
20A Double Pole Switch Isolation Function	WMDP84I
Isolation Function & Flex Outlet	WMDP84FOI
Isolation Function & LED Indicator	WMDP84NI



WMDP85NI

20A Double Pole Switches with Isolator Function- Printed Text

Isolation Function & LED Indicator, Printed WATER HEATER	WMDP85NI
--	-----------------

20A Double Pole Switches with Isolator Function with Flex Outlet - Printed Text

Isolation Function & LED Indicator & Flex Outlet	WMDP84FONI
Isolation Function LED & Flex Outlet, Printed WATER HEATER'	WMDP85FONI

Double Pole Switches (50A)

Characteristics:

- Complies with BS EN 60669-2-4.
- Rated conditional short circuit current (I_{nc}) 1500A tested with Hager **MTN150** 6kA B curve MCB.
- All terminal screws upward facing for ease of installation.
- Clearly printed terminal marking.
- Capacity of each terminal: 2 x 6mm², 1 x 10mm².
- For mounting boxes see selection chart on page 58.
- Supplied with M3.5 x 30mm long fixing screws and screw covers.
- We also offer a bespoke printing service for your individual requirements. Please contact our Estimation Team on 01952 675594 for further details.

Description	Cat ref.
50A Double Pole Switches	
With LED Indicator (1 Gang)	WMDP50N
Vertical with LED Indicator (2 Gang)	WMDP50VN



WMDP50N

50A Double Pole Switches with LED Indicator - Printed Text

Printed 'Cooker'	WMDP50N/CK
Printed 'Hob'	WMDP50N/HB
Printed 'Oven'	WMDP50N/OV
Printed 'Shower'	WMDP50N/SH



WMDP50N/SH

50A Double Pole Vertical Switches with LED Indicator - Printed Text

Printed 'Cooker' (2 Gang)	WMDP50VN/CK
Printed 'Hob' (2 Gang)	WMDP50VN/HB
Printed 'Oven' (2 Gang)	WMDP50VN/OV

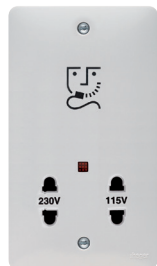

WMSO100

Shaver Socket

Characteristics:

- Complies with BS EN 61558-2-5.
- Shaver socket terminal capacity (to BS6004) 3 x 1.0mm², 2 x 1.5mm², 1 x 2.5mm²
- Designed for use in bathrooms and shower rooms and incorporates a double wound transformer for an earth free supply.
- Designed to supply electric shavers rated 50 VA or less.
- Input 230V a.c. output dual voltage 230V a.c. and 115V a.c. outlets. Rating 20VA on either voltage.
- Primary circuit protected by a self resetting thermal overload device.
- Insertion of shaver plug automatically switches on the transformer.
- Supplied with M3.5 x 30mm long fixing screws and screw covers.

Description

Shaver Socket 115/230 Volt

Cat ref.

WMSO100



WMBTM

Telephone & Data

Characteristics:

- BT sockets comply with BS 6312-2.
- Supplied with fitted cable tie.
- Quick connection with insulation displacement terminals.
- Clearly printed terminal marking.
- Supplied with M3.5 x 20mm long fixing screws and screw covers.

Description

BT Master Telephone Outlet
BT Secondary Telephone Outlet
RJ11 Socket
RJ45 Socket
IDC Tools (bag of 10)

Cat ref.

WMBTM

WMBTS

WMRJ11

WMRJ45

IDCTOOL



WMQX

TV & Satellite

Characteristics:

- TV outlets comply with BS 3041.
- Satellite outlets comply with BS EN 50083-2.
- Fully screened.
- DAB compatible.
- Supplied with M3.5 x 20mm fixing screws.

Description

Single F Type Satellite Outlet Screened
Single Co-Ax TV Socket Outlet Male
Single Co-Ax TV Socket Outlet Female
Double TV & FM/DAB Co-Ax Socket Outlet
Triplexer TV, FM/DAB & Satellite Outlet
Quadplexer TV, FM/DAB, Satellite 1 & Satellite 2 Outlet

Cat ref.

WMSAT

WMTVM

WMTVF

WMDX

WMTX

WMQX

Euro Style Accommodation Plates

Characteristics:

- Carrier plates facilitate installation of industry standard modules.
- Easy to configure for all applications.
- Robust retention of modules in operation.
- Quick release of modules for maintenance.

Description	Cat ref.
Euro Style Accommodation Plates	
1 Module	WMP1EU
2 Modules	WMP2EU
4 Modules	WMP4EU



WMP2EU

Euro Style Modules

Characteristics:

- Please note: these euro modules are industry standard units and are not colour matched to Sollysta plates.

Description	Mod Width	Cat ref. (White)	Cat ref. (Black)
Euro Style Modules			
BT Telephone Master	1	WMMBTM	WMMBTMB
BT Telephone Secondary	1	WMMBTS	WMMBTSB
RJ11 - Modem	1	WMMRJ11	WMMRJ11B
RJ45 - Cat 6 UTP	1	WMMRJ45	WMMRJ45B
Phono Plugs - Red/Black - Gold Plated	1	WMMPP	-
Speaker Terminal Posts - Gold Plated	1	WMMSP	-
Single IEC Female Non Isolated	1	WMMTVF	WMMTVFB
Single IEC Male Non Isolated	1	WMMTVM	WMMTVMB
Single Satellite F Connector	1	WMMSAT	WMMSATB
Single Blank	1	WMMB	WMMBB
PIR Occupancy Sensor 5m	1	WMMPIR05X	-
PIR Occupancy Sensor 10m	1	WMMPIR10X	-
HDMI	2	WMMHDMI	WMMHDMIB
Triplexer - TV, Satellite & FM Radio	2	WMMTX	WMMTXB
Quadplexer - TV, Satellite, FM Radio & Return	2	WMMQX	WMMQXB



WMMBTM

WMMSAT



WMMQXB



WMCS11

Light Switches

Characteristics:

- Complies with BS EN 60669-1.
- 'X' rated - no need to de-rate for fluorescent loads.
- Earth terminal in base.
- Switch will operate at up to an angle of 45°.
- Pull cords 1.5m long.
- Capacity of each terminal: 2 x 1.5mm² conductors.

Description	Cat ref.
6A Ceiling Switch	
1 Way	WMCS11
2 Way	WMCS12



WMCS3PIF

Fan Isolator Switches

Characteristics:

- Complies with BS EN 60669-2-4.
- Terminal capacity: 3 x 1.5mm².
- Supplied with M3.5 x 30mm long fixing screws and screw covers.

Description	Cat ref.
10A 3 Pole Ceiling Switch	
Printed with Fan Symbol & 'Isolator'	WMCS3PIF
Printed 'Isolator'	WMCS3PI
Printed with Fan Symbol	WMCS3PF



WMCS50N

Shower Switches

Characteristics:

- Complies with BS EN 60669-2-4.
- Rated conditional short circuit current (I_{nc}) 1500A tested with Hager **MTN150** 6kA B Curve MCB.
- Suitable for use with showers up to 11.5kW.
- Position of the contacts shown by flag indicator.
- Supplied with M3.5 x 30mm fixing screws.
- Capacity of each terminal: 1 x 16mm² conductors.

Description	Cat ref.
50A 2 Pole Isolating with LED Indicator	WMCS50N



PULLCORD

Accessories for Ceiling Switches

Description	Cat ref.
Single Spare Pull Cord	PULLCORD

Grid Plates

Description	Cat ref.
Grid Plates	
1 Gang	WMGP1
2 Gang	WMGP2
3 Gang	WMGP3
4 Gang	WMGP4
6 (2 x 3) Gang	WMGP6
8 (2 x 4) Gang Grid Plate	WMGP8
1 Gang Grid Plate Grey	WMGP1G
2 Gang Grid Plate Grey	WMGP2G
3 Gang Grid Plate Grey	WMGP3G
4 Gang Grid Plate Grey	WMGP4G
6 (2 x 3) Gang Grid Plate Grey	WMGP6G
8 (2 x 4) Gang Grid Plate Grey	WMGP8G



WMGP2

Grid Frames

Description	Cat ref.
1 Gang	WMGF1
2 Gang	WMGF2
3/4 Gang	WMGF34

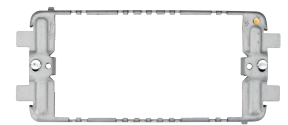

WMGF34

Grid Switches

Characteristics:

- Complies with BS EN 60669-1:2018 switches, BS 5733 fuse carrier.
- Shallowest switch modules which clip in from the front for ease of installation and maintenance.
- Terminal screw can be accessed with modules clipped into frames.
- Frames locate to finished wall level.
- Frames clip together to ease alignment for 6 gang and 8 gang applications.
- 20A Switches suitable for SBL circuits to a maximum of 250W SBL.
- We also offer a bespoke printing service for your individual requirements. Please contact our Sales Service Centre on 01952 675612 for further details.

Description	Cat ref. White Insert	Cat ref. Black Insert
Grid Switches		
Blank Module	WMGB1	-
20AX 2 Way Single Pole Switch	WMGS12	-
20A Intermediate Switch	WMGS16	-
20A 2 Way Retractive Switch	WMGS22R	-
20A 1 Way Double Pole Switch	WMGSDP2	-
20A 1 Way Double Pole Switch with LED Indicator	WMGSDP2N	-
20A Double Pole Key Switch	WMGKS	-
20A Double Pole Key Switch Printed 'Emergency Lighting Test'	WMGKS/EL	-
13A Fuse Carrier	WMGFU13	-
Dimmer Slave Switch	WMGSD1S	WMGSD1SB
Dimmer Switch Leading Edge	WMGSD1L	WMGSD1LB
Dimmer Switch Trailing Edge	WMGSD1T	WMGSD1TB
Red Indicator	WMINDRED	WMINDREDB
2 Way & Centre Off Latching Switch	WMGS13L	WMGS13LB
2 Way & Centre Off Latching Switch Red Rocker	WMGS13LR	-
2 Way & Centre Off Retractive Switch	WMGS13R	WMGS13RB
2 Way & Centre Off Retractive Switch Red Rocker	WMGS13RR	-
13A Fused Connection Unit Unswitched with LED Indicator	WMGSU83N	-



WMGKS



WMGB1



WMINDRED



WMGSDP2/CHD



WMGSDP2/EF



WMGSDP2B/DW



WMGSDP2NB-WM

Grid Switches (Continued)

Characteristics:

- Complies with BS EN 60669-1:2018 switches, BS 5733 fuse carrier.
- Shallowest switch modules which clip in from the front for ease of installation and maintenance.
- Terminal screw can be accessed with modules clipped into frames.
- Frames locate to finished wall level.
- Frames clip together to ease alignment for 6 gang and 8 gang applications.
- 20A Switches suitable for SBL circuits to a maximum of 250W SBL
- We also offer a bespoke printing service for your individual requirements. Please contact our Sales Service Centre on 01952 675612 for further details.

Description	Cat ref. White Insert	Cat ref. Black Insert
20A 1 Way Double Pole Grid Switches - Printed		
Printed 'Boiler'	WMGSDP2/BOI	-
Printed 'Cooker Hood'	WMGSDP2/CHD	WMGSDP2B/CHD
Printed 'Dishwasher'	WMGSDP2/DW	WMGSDP2B/DW
Printed 'Extract Fan'	WMGSDP2/EF	WMGSDP2B/EF
Printed 'Fridge Freezer'	WMGSDP2/FF	WMGSDP2B/FF
Printed 'Freezer'	WMGSDP2/FRE	WMGSDP2B/FRE
Printed 'Fridge'	WMGSDP2/FRI	WMGSDP2B/FRI
Printed 'Hob'	WMGSDP2/HB	WMGSDP2B/HB
Printed 'Heating'	WMGSDP2/HTG	WMGSDP2B/HTG
Printed 'Microwave'	WMGSDP2/MW	WMGSDP2B/MW
Printed 'Micro Wave'	WMGSDP2MW2	-
Printed 'Tumble Dryer'	WMGSDP2/TD	WMGSDP2B/TD
Printed 'Waste Disposal'	WMGSDP2/WD	WMGSDP2B/WD
Printed 'Washing Machine'	WMGSDP2/WM	WMGSDP2B/WM
Printed 'Oven'	WMGSDP2/OV	WMGSDP2B/OV
Printed 'Wine Cooler'	WMGSDP2/WC	WMGSDP2B/WC
Printed 'Hot Water'	WMGSDP2/HW	WMGSDP2B/HW
Printed 'Coffee Maker'	WMGSDP2/CM	WMGSDP2B/CM
Printed 'Hot Drawer'	WMGSDP2/HD	WMGSDP2B/HD
Printed 'Fan Boost'	WMGSDP2/FB	WMGSDP2B/FB
Printed 'Outside Light'	WMGSDP2/OL	-
Printed 'Outside Socket'	WMGSDP2/OS	-
Printed 'Plinth Heater'	WMGSDP2/PH	-
20A 1 Way Double Pole Grid Switches with LED Indicator - Printed		
Printed 'Cooker Hood'	WMGSDP2N/CHD	WMGSDP2NB/CHD
Printed 'Dishwasher'	WMGSDP2N/DW	WMGSDP2NB/DW
Printed 'Extract Fan'	WMGSDP2N/EF	WMGSDP2NB/EF
Printed 'Fridge Freezer'	WMGSDP2N/FF	WMGSDP2NB/FF
Printed 'Freezer'	WMGSDP2N/FRE	WMGSDP2NB/FRE
Printed 'Fridge'	WMGSDP2N/FRI	WMGSDP2NB/FRI
Printed 'Hob'	WMGSDP2N/HB	WMGSDP2NB/HB
Printed 'Heating'	WMGSDP2N/HTG	WMGSDP2NB/HTG
Printed 'Microwave'	WMGSDP2N/MW	WMGSDP2NB/MW
Printed 'Tumble Dryer'	WMGSDP2N/TD	WMGSDP2NB/TD
Printed 'Waste Disposal'	WMGSDP2N/WD	WMGSDP2NB/WD
Printed 'Washing Machine'	WMGSDP2N/WM	WMGSDP2NB/WM
Printed 'Oven'	WMGSDP2N/OV	-
Printed 'Outside Light'	WMGSDP2N/OL	-
Printed 'Outside Socket'	WMGSDP2N/OS	-
Printed 'Plinth Heater'	WMGSDP2N/PH	-

Blank Plates

Single Blank Plate
Twin Blank Plate

WMP1
WMP2



WMP1



WMP2

Pattress Boxes

Characteristics:

- Complies with BS EN 60670-1.
- Depth quoted is internal depth.
- Colour and footprint match all Sollysta White Moulded wiring accessories.

Description

Single 20mm Deep Moulded Box
Single 28mm Deep Moulded Box
Single 46mm Deep Moulded Box
Twin 28mm Deep Moulded Box
Twin 46mm Deep Moulded Box with Cable Clamps
46mm Deep Moulded Shaver Box
20mm Single to Twin Converter Frame
Single 14mm Deep Spacer for Base Flex Outlet

Cat ref.

WMPB1/20
WMPB1/28
WMPB1/46
WMPB2/28
WMPB2/46CC
WMPB2/46
WMPB2/20
WMPB1/BFO

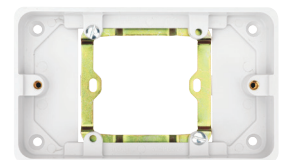

WMPB2/20



WMPB2/28

Accessories

Description

Single Spare Pull Cord
Pack of 100 Push Fit Screw Covers
IDC Tools (bag of 10)

Cat ref.

PULLCORD
SCREWCOVER
IDCTOOL



PULLCORD



WMPS12WG



WMSS82OG



WMSS82-USBGAC



WMDP84NGI

Part M Wiring Accessories

Characteristics:

- Designed to satisfy Buildings Regulations Approved Document M (referred to as Part M)
- All products comply with their relevant British Standards
- Switches have wide rockers and dark face plates for clear visibility and ease of actuation
- Sockets have outboard rockers to ensure correct switching of appliances and dark face plates for ease of identification of switch position
- 10AX Switches Suitable for SBL circuits to a maximum of 100 W SBL
- 20A Switches suitable for SBL circuits to a maximum of 250W SBL
- Grid modules can be found on page 23. Euro modules can be found on page 21.
- WMDP84NGI & WMDP50N* Complies with BS EN 60669-2-4.

Description	Cat ref. (Grey Faceplate)
Wall Switches	
10AX 1 Gang 2 Way Wide Rocker	WMPS12WG
10AX 2 Gang 2 Way Wide Rocker	WMPS22WG
Intermediate Switch	
Wide Rocker	WMPS16WG
Push Switches	
Wide Rocker	WMPS12RWG
Wide Rocker Printed 'Fan Boost'	WMPS12RWG/FB
Double Pole Switched Socket Outlets	
13A 1 Gang	WMSS81G
13A 2 Gang with Outboard Rockers	WMSS82OG
13A 2 Gang Double Pole Dual Earth & Two USB Ports (Type A+A)	WMSS82USBG
13A 2 Gang Double Pole Dual Earth & Two USB Ports (Type A+C)	WMSS82-USBGAC
Switched Fused Connection Units	
13A with LED Indicator	WMSSU83NG
13A with LED Indicator Printed 'Extract Hood'	WMSSU83NG/EH
Double Pole Switches	
20A 1 Gang with LED Indicator	WMDP84NG
50A 1 Gang with LED Indicator	WMDP50NG
50A 1 Gang with LED Indicator Printed 'Cooker'	WMDP50NG/CK
13A Switched Fused Connection Units (FCU With Flex Outlet)	WMSSU83FONG
Grid Plates	
1 Gang Grid Plate	WMGP1G
2 Gang Grid Plate	WMGP2G
3 Gang Grid Plate	WMGP3G
4 Gang Grid Plate	WMGP4G
6 Gang Grid Plate (2 x 3)	WMGP6G
8 Gang Grid Plate (2 x 4)	WMGP8G
Euro Style Accommodation Plates	
1 Module	WMP1EUG
2 Modules	WMP2EUG
4 Modules	WMP4EUG
Double Pole Switches (20A) with Isolator Function	
20A Double Pole Switch Isolation Function & LED Indicator, Grey Plate	WMDP84NGI

Specific Equipment Wiring Accessories

Characteristics:

- Red rockers aid ease of identification for safe switching of specific equipment
- Red face plates ensure products are easy to locate
- A range of printed options is available for specific functions

Description	Cat ref. (White Faceplate, Red Rocker)	Cat ref. (Red Faceplate, Red Rocker)
Double Pole Switched Socket Outlets		
13A 1 Gang	WMSS81R	WMSS81RR
13A 2 Gang	WMSS82R	WMSS82RR
13A 2 Gang with Outboard Rockers	WMSS82OR	WMSS82ORR
13A 2 Gang Switched Socket Printed 'Cleaners Socket'	WMSS82R/CS	-
13A 2 Gang Switched Socket Printed 'UPS Protected'	WMSS82R/UPS	-
Switched Fused Connection Units		
13A Fused Connection Unit Switched	WMSSU83R	-
13A Fused Connection Unit Red Face (White Fuse Cover)	WMSSU83R	-
13A Fused Connection Unit Switched	-	WMSSU83RR

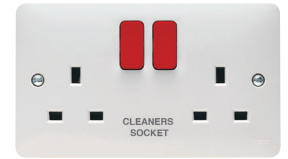

WMSS82R/CS



WMSS82ORR

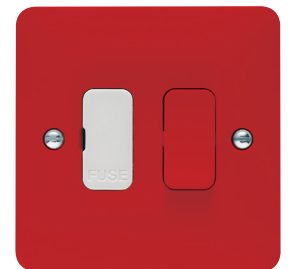

WMSSU83RR



WRPS12PSB



WRPS22BSW

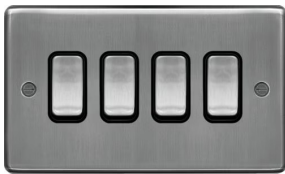

WRPS12BSW



Wall Switches Raised Plate

Characteristics:

- Unique patented LOOP terminal to allow neutral looping at the switch.
- Complies with BS EN 60669-1:2018, a.c only.
- 'X' rated - No need to de-rate for fluorescent loads.
- Capacity of each terminal 2 x 4.0mm² conductors.
- 10AX Switches Suitable for SBL circuits to a maximum of 100 W SBL
- For mounting boxes see selection chart on page 58.
- For multi-gang switches, use of a 25mm mounting box will provide increased wiring space.
- Supplied with M3.5 x 20mm long fixing screws.

Description	Cat ref. White Insert	Cat ref. Black Insert
-------------	-----------------------	-----------------------

Raised Plate 10AX 1 Gang 2 Way

Polished Steel	WRPS12PSW	WRPS12PSB
Brushed Steel	WRPS12BSW	WRPS12BSB

Raised Plate 10AX 2 Gang 2 Way

Polished Steel	WRPS22PSW	WRPS22PSB
Brushed Steel	WRPS22BSW	WRPS22BSB

Raised Plate 10AX 3 Gang 2 Way

Polished Steel	WRPS32PSW	WRPS32PSB
Brushed Steel	WRPS32BSW	WRPS32BSB

Raised Plate 10AX 4 Gang 2 Way

Polished Steel	WRPS42PSW	WRPS42PSB
Brushed Steel	WRPS42BSW	WRPS42BSB

Raised Plate 10AX 1 Gang 2 Way Wide Rocker

Polished Steel	WRPS12WPSW	WRPS12WPB
Brushed Steel	WRPS12WBSW	WRPS12WBSB

Raised Plate 10AX 2 Gang 2 Way Wide Rocker

Polished Steel	WRPS22WPSW	WRPS22WPB
Brushed Steel	WRPS22WBSW	WRPS22WBSB

Raised Plate Intermediate Switch

Polished Steel	WRPS16PSW	WRPS16PSB
Brushed Steel	WRPS16BSW	WRPS16BSB

Wall Switches Flat Plate

Characteristics:

- Unique patented LOOP terminal to allow neutral looping at the switch.
- Complies with BS EN 60669-1:2018, a.c only.
- 'X' rated - No need to de-rate for fluorescent loads.
- Capacity of each terminal 2 x 4.0mm² conductors.
- 10AX Switches Suitable for SBL circuits to a maximum of 100 W SBL.
- For mounting boxes see selection chart on page 58.
- For multi-gang switches use of a 25mm mounting box will provide increased wiring space.
- Supplied with M3.5 x 20mm long fixing screws.

Description	Cat ref. White Insert	Cat ref. Black Insert
-------------	-----------------------	-----------------------

Flat Plate 10AX 1 Gang 2 Way

Polished Steel	WFPS12PSW	WFPS12PSB
Brushed Steel	WFPS12BSW	WFPS12BSB

Flat Plate 10AX 2 Gang 2 Way

Polished Steel	WFPS22PSW	WFPS22PSB
Brushed Steel	WFPS22BSW	WFPS22BSB

Flat Plate 10AX 3 Gang 2 Way

Polished Steel	WFPS32PSW	WFPS32PSB
Brushed Steel	WFPS32BSW	WFPS32BSB

Flat Plate 10AX 4 Gang 2 Way

Polished Steel	WFPS42PSW	WFPS42PSB
Brushed Steel	WFPS42BSW	WFPS42BSB

Flat Plate 10AX 1 Gang 2 Way Wide Rocker

Polished Steel	WFPS12WPSW	WFPS12WPSB
Brushed Steel	WFPS12WBSW	WFPS12WBSB

Flat Plate 10AX 2 Gang 2 Way Wide Rocker

Polished Steel	WFPS22WPSW	WFPS22WPSB
Brushed Steel	WFPS22WBSW	WFPS22WBSB

Flat Plate Intermediate Switch

Polished Steel	WFPS16PSW	WFPS16PSB
Brushed Steel	WFPS16BSW	WFPS16BSB



WFPS22PSW



WFPS22WBSW



WFPS32PSB



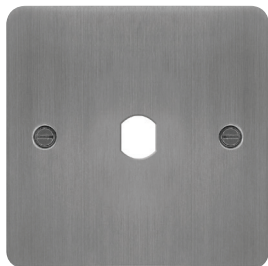

WFDRP1BSKIT

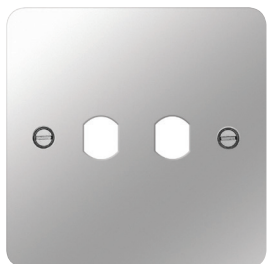

WFDRP1PSKIT

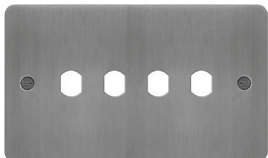

WFDRP4BSKIT

Dimmer Plate Kits

Characteristics:

- Suitable for most D shaft push and rotary dimmer switch modules
- Maintains Sollysta aesthetic for a wide range of manufacturers switches
- Plate and matching button(s) supplied
- Supplied with M3.5 x 30mm long fixing screws and screw covers.

Description	Cat ref. Flat Plate	Cat ref. Raised Plate
1 Gang Dimmer Switch Plate Kit		
Polished Steel	WFDRP1PSKIT	WRDRP1PSKIT
Brushed Steel	WFDRP1BSKIT	WRDRP1BSKIT
2 Gang Dimmer Switch Plate Kit		
Polished Steel	WFDRP2PSKIT	WRDRP2PSKIT
Brushed Steel	WFDRP2BSKIT	WRDRP2BSKIT
3 Gang Dimmer Switch Plate Kit		
Polished Steel	WFDRP3PSKIT	WRDRP3PSKIT
Brushed Steel	WFDRP3BSKIT	WRDRP3BSKIT
4 Gang Dimmer Switch Plate Kit		
Polished Steel	WFDRP4PSKIT	WRDRP4PSKIT
Brushed Steel	WFDRP4BSKIT	WRDRP4BSKIT

Isolator Switches Raised Plate

Characteristics:

- Complies with BS EN 60669-2-4.
- Rated conditional short circuit current (I_{nc}) 1500A tested with Hager MTN150 6kA B curve MCB.
- All terminals are upward facing with clearly printed terminal markings for ease of installation.
- Capacity of each terminal 2 x 6mm², 1 x 10mm².
- For mounting boxes see selection chart on page 58.
- WR references supplied with M3.5 x 30mm long fixing screws.
- WF references supplied with M3.5 x 20mm long fixing screws.

Description	Cat ref. White Insert	Cat ref. Black Insert
Raised Plate 3 Pole Fan Isolator Switch		
Polished Steel	WRPS3PIPSW	WRPS3PIPSB
Brushed Steel	WRPS3PIBSW	WRPS3PIBSB



WRPS3PIPSW

Isolator Switches Flat Plate

Description	Cat ref. White Insert	Cat ref. Black Insert
Flat Plate 3 Pole Fan Isolator Switch		
Polished Steel	WFPS3PIPSW	WFPS3PIPSB
Brushed Steel	WFPS3PIBSW	WFPS3PIBSB



WFPS3PIBSB

Double Pole Switches (20A) with Isolator Function

Description	Cat ref. White Insert	Cat ref. Black Insert
Raised Plate		
Polished Steel	WRDP84NIPSW	WRDP84NIPSB
Brushed Steel	WRDP84NIBSW	WRDP84NIBSB



WRDP84NIBSW



WRSS81BSW

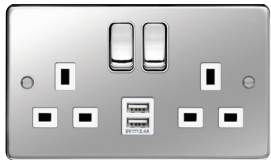

WRSS82PSW-USB



WRSS82BSB-USBAC

Socket Outlets Raised Plates

Characteristics:

- Unique patented three part safety shutter.
- Complies with BS 1363 Part 2, a.c only.
- Double pole switching mechanism on switched sockets.
- Twin socket comes with twin earth as standard.
- All terminals are upward facing with clearly printed terminal markings for ease of installation.
- Capacity of each terminal: 3 x 4mm² conductors, switched & unswitched (for other sized conductors see terminal capacities on page 59).
- For mounting boxes see selection chart on page 58.
- WR references supplied with M3.5 x 30mm long fixing screws.
- WF references supplied with M3.5 x 20mm long fixing screws.
- **Sockets with USB connections - Warning:** To avoid possible damage to the product or spurious insulation readings, please disconnect the product before carrying out insulation resistance testing.
- **Sockets with USB connections:** USB output: 5V d.c. 3.1A total max.
- All decorative USB sockets come with spacer colour matched to insert and 30mm & 20mm screws.

Description	Cat ref. White Insert	Cat ref. Black Insert
Raised Plate 1 Gang Double Pole Switched Socket		
Polished Steel	WRSS81PSW	WRSS81PSB
Brushed Steel	WRSS81BSW	WRSS81BSB

Raised Plate 2 Gang Double Pole Switched Socket Dual Earth

Polished Steel	WRSS82PSW	WRSS82PSB
Brushed Steel	WRSS82BSW	WRSS82BSB

Raised Plate 5A 1 Gang Unswitched Socket

Polished Steel	WRS51PSW	WRS51PSB
Brushed Steel	WRS51BSW	WRS51BSB

Raised Plate 2 Gang Double Pole Dual Earth Switched Socket & Two USB Ports (Type A+A)

Polished Steel	WRSS82PSW-USB	WRSS82PSB-USB
Brushed Steel	WRSS82BSW-USB	WRSS82BSB-USB

Raised Plate 2 Gang Double Pole Dual Earth Switched Socket & Two USB Ports (Type A + C)

Polished Steel	WRSS82PSW-USBAC	WRSS82PSB-USBAC
Brushed Steel	WRSS82BSW-USBAC	WRSS82BSB-USBAC

Socket Outlets Flat Plates

Description	Cat ref. White Insert	Cat ref. Black Insert
Flat Plate 1 Gang Double Pole Switched Socket		
Polished Steel	WFSS81PSW	WFSS81PSB
Brushed Steel	WFSS81BSW	WFSS81BSB



WFSS81BSW

Description	Cat ref. White Insert	Cat ref. Black Insert
Flat Plate 2 Gang Double Pole Switched Socket Dual Earth		
Polished Steel	WFSS82PSW	WFSS82PSB
Brushed Steel	WFSS82BSW	WFSS82BSB

Description	Cat ref. White Insert	Cat ref. Black Insert
Flat Plate 5A 1 Gang Unswitched Socket		
Polished Steel	WFSS51PSW	WFSS51PSB
Brushed Steel	WFSS51BSW	WFSS51BSB

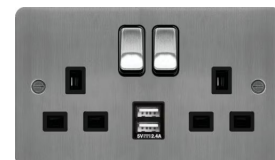

WFSS82BSB-USBS

Description	Cat ref. White Insert	Cat ref. Black Insert
Flat Plate 2 Gang Double Pole Dual Earth Switched Socket & Two USB Ports (Type A+A)		
Polished Steel	WFSS82PSW-USBS	WFSS82PSB-USBS
Brushed Steel	WFSS82BSW-USBS	WFSS82BSB-USBS

Description	Cat ref. White Insert	Cat ref. Black Insert
Flat Plate 2 Gang Double Pole Dual Earth Switched Socket & Two USB Ports (Type A + C)		
Polished Steel	WFSS82PSW-USBSAC	WFSS82PSB-USBSAC
Brushed Steel	WFSS82BSW-USBSAC	WFSS82BSB-USBSAC

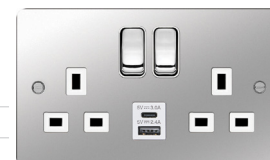

WFSS82PSW-USBSAC

**Decorative
Cooker Control Units**

Cooker Control Unit Raised Plate

Characteristics:

- Complies with BS 4177.
- Switch and socket are double pole with twin earth as standard.
- Main switch is suitable for isolation.
- All terminals are upward facing with clearly printed terminal markings for ease of installation.
- Capacity of terminals: 2 x 6.0mm², 1 x 16.0mm².
- For mounting boxes see selection chart on page 58.
- WR references supplied with M3.5 x 30mm long fixing screws.
- WF references supplied with M3.5 x 20mm long fixing screws.

Description	Cat ref. White Insert	Cat ref. Black Insert
Raised Plate 45A Cooker Control Unit		
Polished Steel	WRCC50NPSW	WRCC50NPSB
Brushed Steel	WRCC50NBSW	WRCC50NBSB



WRCC50NPSB



WRCC50NBSW

Cooker Control Unit Flat Plate

Description	Cat ref. White Insert	Cat ref. Black Insert
Flat Plate 45A Cooker Control Unit		
Polished Steel	WFCC50NPSW	WFCC50NPSB
Brushed Steel	WFCC50NBSW	WFCC50NBSB



WFCC50NPSW



WRSSU83FOBSW

Fused Connection Units Raised Plate

Characteristics:

- Complies with BS 1363-4.
- Single screw fast fix cable clamp accommodates up to 2.5mm² flexible cord.
- All terminals are upward facing with clearly printed terminal markings for ease of installation.
- Capacity of each terminal 2 x 6.0 mm² conductors.
- For mounting boxes see selection chart on page 58.
- WR references supplied with M3.5 x 30mm long fixing screws.
- WF references supplied with M3.5 x 20mm long fixing screws.

Note: For constant 3kW loads not requiring overload protection, consideration should be given to the use of 20A DP switches instead (page 35).



WRSU83PSB

Description	Cat ref. White Insert	Cat ref. Black Insert
Raised Plate 13A FCU Switched		
Polished Steel	WRSSU83PSW	WRSSU83PSB
Brushed Steel	WRSSU83BSW	WRSSU83BSB

Raised Plate 13A FCU Switched with Flex Outlet

Polished Steel	WRSSU83FOPSW	WRSSU83FOPSB
Brushed Steel	WRSSU83FOBSW	WRSSU83FOBSB

Raised Plate 13A FCU Unswitched

Polished Steel	WRSU83PSW	WRSU83PSB
Brushed Steel	WRSU83BSW	WRSU83BSB



WFSU83BSW

Fused Connection Units Flat Plate

Description	Cat ref. White Insert	Cat ref. Black Insert
Flat Plate 13A FCU Switched		
Polished Steel	WFSSU83PSW	WFSSU83PSB
Brushed Steel	WFSSU83BSW	WFSSU83BSB

Flat Plate 13A FCU Switched with Flex Outlet

Polished Steel	WFSSU83FOPSW	WFSSU83FOPSB
Brushed Steel	WFSSU83FOBSW	WFSSU83FOBSB



WFSSU83FOBSB

Flat Plate 13A FCU Unswitched

Polished Steel	WFSU83PSW	WFSU83PSB
Brushed Steel	WFSU83BSW	WFSU83BSB

Double Pole Switches Raised Plate (20A)

Characteristics:

- Complies with BS EN 60669-1 a.c. only.
- Single screw fast fix cable clamp accommodates up to 2.5mm² flexible cord.
- All terminals are upward facing with clearly printed terminal markings for ease of installation.
- Capacity of each terminal 2 x 6.0mm² conductors.
- For mounting boxes see selection chart on page 58.
- WR references supplied with M3.5 x 30mm long fixing screws.
- WF references supplied with M3.5 x 20mm long fixing screws.

Description	Cat ref. White Insert	Cat ref. Black Insert
-------------	-----------------------	-----------------------

Raised Plate 20A Double Pole Switch

Polished Steel	WRDP84PSW	WRDP84PSB
Brushed Steel	WRDP84BSW	WRDP84BSB

Raised Plate 20A Double Pole Switch with Flex Outlet

Polished Steel	WRDP84FOPSW	WRDP84FOPSB
Brushed Steel	WRDP84FOBSW	WRDP84FOBSB

Raised Plate 20A Double Pole Switch with LED Indicator

Polished Steel	WRDP84NPSW	WRDP84NPSB
Brushed Steel	WRDP84NBSW	WRDP84NBSB



WRDP84BSB



WRDP84PSW

Double Pole Switches Flat Plate (20A)

Description	Cat ref. White Insert	Cat ref. Black Insert
-------------	-----------------------	-----------------------

Flat Plate 20A Double Pole Switch

Polished Steel	WFDP84PSW	WFDP84PSB
Brushed Steel	WFDP84BSW	WFDP84BSB

Flat Plate 20A Double Pole Switch with Flex Outlet

Polished Steel	WFDP84FOPSW	WFDP84FOPSB
Brushed Steel	WFDP84FOBSW	WFDP84FOBSB

Flat Plate 20A Double Pole Switch with LED Indicator

Polished Steel	WFDP84NPSW	WFDP84NPSB
Brushed Steel	WFDP84NBSW	WFDP84NBSB



WFDP84FOPSW



WFDP84BSW



WRDP50NBSB

Double Pole Switches Raised Plate (50A)

Characteristics:

- Complies with BS EN 60669-2-4.
- Rated conditional short circuit current (I_{nc}) 1500A tested with Hager **MTN150** 6kA B curve MCB.
- All terminals are upward facing with clearly printed terminal markings for ease of installation.
- Capacity of each terminal 2 x 6mm², 1 x 10mm².
- For mounting boxes see selection chart on page 58.
- WR references supplied with M3.5 x 30mm long fixing screws.
- WF references supplied with M3.5 x 20mm long fixing screws.

Description	Cat ref. White Insert	Cat ref. Black Insert
Raised Plate 50A Double Pole Switch 1 Gang with LED Indicator		
Polished Steel	WRDP50NPSW	WRDP50NPSB
Brushed Steel	WRDP50NBSW	WRDP50NBSB



WFDP50NPSW

Double Pole Switches Flat Plate (50A)

Description	Cat ref. White Insert	Cat ref. Black Insert
Flat Plate 50A Double Pole Switch 1 Gang with LED Indicator		
Polished Steel	WFDP50NPSW	WFDP50NPSB
Brushed Steel	WFDP50NBSW	WFDP50NBSB

Shaver Socket Raised Plate

Characteristics:

- Complies with BS EN 61558-2-5.
- Capacity of each terminal 2 x 2.5mm² conductors.
- Designed for use in bath/shower rooms & incorporates a double wound transformer for an earth free supply.
- Designed to supply electric shavers rated 50 VA or less.
- Input 230V a.c. output dual voltage 230V a.c. and 115V a.c. outlets.
- Rating 20VA on either voltage.
- Primary circuit protected by a self resetting thermal overload device.
- Insertion of shaver plug automatically switches on the transformer.
- WR references supplied with M3.5 x 30mm long fixing screws.
- WF references supplied with M3.5 x 20mm long fixing screws.



WRSO100PSW

Description	Cat ref. White Insert	Cat ref. Black Insert
Raised Plate 115/230V Shaver Socket		
Polished Steel	WRSO100PSW	WRSO100PSB
Brushed Steel	WRSO100BSW	WRSO100BSB

Shaver Socket Flat Plate

Description	Cat ref. White Insert	Cat ref. Black Insert
Flat Plate 115/230V Shaver Socket		
Polished Steel	WFSO100PSW	WFSO100PSB
Brushed Steel	WFSO100BSW	WFSO100BSB



WFSO100PSB



WRBTMBSW

Telephone & Data Raised Plate

Characteristics:

- BT sockets comply with BS 6312-2.
- Supplied with fitted cable tie.
- Quick connection with insulation displacement terminals.
- Clearly printed terminal marking.
- WR references supplied with M3.5 x 30mm long fixing screws.
- WF references supplied with M3.5 x 20mm long fixing screws.

Description	Cat ref. White Insert	Cat ref. Black Insert
Raised Plate BT Master Telephone Outlet		
Polished Steel	WRBTMPSW	WRBTMPSB
Brushed Steel	WRBTMBSW	WRBTMBSB

Raised Plate BT Secondary Telephone Outlet

Polished Steel	WRBTSPSW	WRBTSPSB
Brushed Steel	WRBTBSW	WRBTBSB

Raised Plate RJ45 Socket

Polished Steel	WRRJ45PSW	WRRJ45PSB
Brushed Steel	WRRJ45BSW	WRRJ45BSB



WFBTMBSB

Telephone & Data Flat Plate

Description	Cat ref. White Insert	Cat ref. Black Insert
Flat Plate BT Master Telephone Outlet		
Polished Steel	WFBTSPSW	WFBTSPSB
Brushed Steel	WFBTBSW	WFBTBSB

Flat Plate BT Secondary Telephone Outlet

Polished Steel	WFBTSPSW	WFBTSPSB
Brushed Steel	WFBTBSW	WFBTBSB

Flat Plate RJ45 Socket

Polished Steel	WFRJ45PSW	WFRJ45PSB
Brushed Steel	WFRJ45BSW	WFRJ45BSB



WFBTSPSW

TV & Satellite Raised Plate

Characteristics:

- TV outlets comply with BS 3041.
- Satellite outlets comply with BS EN 50083-2.
- Fully screened.
- DAB compatible.
- WR references supplied with M3.5 x 30mm long fixing screws.
- WF references supplied with M3.5 x 20mm long fixing screws.

Description	Cat ref. White Insert	Cat ref. Black Insert
Raised Plate Single F Type Satellite Outlet Screened		
Polished Steel	WRSATPSW	WRSATPSB
Brushed Steel	WRSATBSW	WRSATBSB



WRSATBSW

Raised Plate Single CO-AX TV Outlet Female

Polished Steel	WRTVFPSW	WRTVFPSB
Brushed Steel	WRTVFBSW	WRTVFBSB



WRSATPSW

Raised Plate Triplexer TV, FM/DAB & Satellite Outlet

Polished Steel	WRTXPSW	WRTXPSB
Brushed Steel	WRTXBSW	WRTXBSB

Raised Plate Quadplexer TV, FM/DAB, Satellite 1 & Satellite 2 Outlet

Polished Steel	WRQXPSW	WRQXPSB
Brushed Steel	WRQXBSW	WRQXBSB



WRTXBSB

TV & Satellite Flat Plate

Description	Cat ref. White Insert	Cat ref. Black Insert
Flat Plate Single F Type Satellite Outlet Screened		
Polished Steel	WFSATPSW	WFSATPSB
Brushed Steel	WFSATBSW	WFSATBSB



WFTVFBSW

Flat Plate Single CO-AX TV Outlet Female

Polished Steel	WFTVFPSW	WFTVFPSB
Brushed Steel	WFTVFBSW	WFTVFBSB

Flat Plate Triplexer TV, FM/DAB & Satellite Outlet

Polished Steel	WFTXPSW	WFTXPSB
Brushed Steel	WFTXBSW	WFTXBSB



WFDXBSW

Flat Plate Quadplexer TV, FM/DAB, Satellite 1 & Satellite 2 Outlet

Polished Steel	WFQXPSW	WFQXPSB
Brushed Steel	WFQXBSW	WFQXBSB



WRP1EUPSB



WRP2EUPSW



WFP1EUBSB



WFP4EUPSW



WFTVLPPSW



WFTVBOX47



WFTVLPHBSB

Euro Frontplates Raised Plate

Characteristics:

- Carrier plates facilitate installation of industry standard modules.
- Easy to configure for all applications.
- Quick release of modules for maintenance.
- WR references supplied with M3.5 x 30mm long fixing screws.
- WF references supplied with M3.5 x 20mm long fixing screws.

Description	Cat ref. White Insert	Cat ref. Black Insert
Raised Plate 1 Module		
Polished Steel	WRP1EUPSW	WRP1EUPSB
Brushed Steel	WRP1EUBSW	WRP1EUBSB

Raised Plate 2 Modules

Polished Steel	WRP2EUPSW	WRP2EUPSB
Brushed Steel	WRP2EUBSW	WRP2EUBSB

Raised Plate 4 Modules

Polished Steel	WRP4EUPSW	WRP4EUPSB
Brushed Steel	WRP4EUBSW	WRP4EUBSB

Euro Frontplates Flat Plate

Description	Cat ref. White Insert	Cat ref. Black Insert
Flat Plate 1 Module		
Polished Steel	WFP1EUPSW	WFP1EUPSB
Brushed Steel	WFP1EUBSW	WFP1EUBSB

Flat Plate 2 Modules

Polished Steel	WFP2EUPSW	WFP2EUPSB
Brushed Steel	WFP2EUBSW	WFP2EUBSB

Flat Plate 4 Modules

Polished Steel	WFP4EUPSW	WFP4EUPSB
Brushed Steel	WFP4EUBSW	WFP4EUBSB

Euro Lounge Plates

Description	Cat ref. White Insert	Cat ref. Black Insert
Flat Plate Lounge Plate for TV, Power & Data		
Polished Steel	WFTVLPPSW	WFTVLPPSB
Brushed Steel	WFTVLPBSW	WFTVLPBSB
White Metal	WFTVLPWW	

Raised Plate Lounge Plate for TV, Power & Data

White Metal	WRTVLPWW	
Brushed Steel (2G with USB A+C)	WRTVLPBWSW	WRTVLPBBSB

Flat Plate 4 Modules

Steel (37mm deep)	WFTVBOX	
Steel (37mm deep)	WFTVBOX47	
Steel Half Height (for WRTVLPH***)	WFTVBOX47H	

Euro Style Modules

Description	Mod Width	Cat ref. (White)	Cat ref. (Black)
BT Telephone Master Euromodule	1	WMMBTM	WMMBTMB
BT Telephone Secondary Euromodule	1	WMMBTS	WMMBTSB
RJ11 - Modem Euromodule	1	WMMRJ11	WMMRJ11B
RJ45 - Cat 6 UTP Euromodule	1	WMMRJ45	WMMRJ45B
Phono Plugs - Red/Black - Gold Plated Euromodule	1	WMMPP	-
Speaker Terminal Posts - Gold Plated Euromodule	1	WMMSP	-
Single IEC Female Non Isolated Euromodule	1	WMMTVF	WMMTVFB
Single IEC Male Non Isolated Euromodule	1	WMMTVM	WMMTVMB
Single Satellite F Connector Euromodule	1	WMMSAT	WMMSATB
Single Blank Euromodule	1	WMMB	WMMBB
PIR Occupancy Sensor Euromodule 5m	1	WMMPIR05X	-
PIR Occupancy Sensor Euromodule 10m	1	WMMPIR10X	-
HDMI Module	2	WMMHDMI	WMMHDMIB
Triplexer - TV, Satellite & FM Radio Euromodule	2	WMMTX	WMMTXB
Quadplexer - TV, Satellite, FM Radio & Return Euromodule	2	WMMQX	WMMQXB



WMMBTM WMMBTS



WMMQXB



WFGP1PS

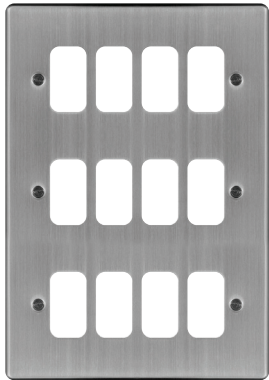

WRGP12BS

Grid Plates Raised Plate

Description	Cat ref.
Raised Plate 1 Gang Grid Plate	
Polished Steel	WRGP1PS
Brushed Steel	WRGP1BS
Raised Plate 2 Gang Grid Plate	
Polished Steel	WRGP2PS
Brushed Steel	WRGP2BS
Raised Plate 3 Gang Grid Plate	
Polished Steel	WRGP3PS
Brushed Steel	WRGP3BS
Raised Plate 4 Gang Grid Plate	
Polished Steel	WRGP4PS
Brushed Steel	WRGP4BS
Raised Plate 6 Gang (3 x 2) Grid Plate	
Polished Steel	WRGP6PS
Brushed Steel	WRGP6BS
Raised Plate 8 Gang (4 x 2) Grid Plate	
Polished Steel	WRGP8PS
Brushed Steel	WRGP8BS
Raised Plate 12 Gang (4 x 3) Grid Plate	
Polished Steel	WRGP12PS
Brushed Steel	WRGP12BS

Grid Plates Flat Plate

Description	Cat ref.
Flat Plate 1 Gang Grid Plate	
Polished Steel	WFGP1PS
Brushed Steel	WFGP1BS
Flat Plate 2 Gang Grid Plate	
Polished Steel	WFGP2PS
Brushed Steel	WFGP2BS
Flat Plate 3 Gang Grid Plate	
Polished Steel	WFGP3PS
Brushed Steel	WFGP3BS
Flat Plate 4 Gang Grid Plate	
Polished Steel	WFGP4PS
Brushed Steel	WFGP4BS
Flat Plate 6 Gang (3 x 2) Grid Plate	
Polished Steel	WFGP6PS
Brushed Steel	WFGP6BS
Flat Plate 8 Gang (4 x 2) Grid Plate	
Polished Steel	WFGP8PS
Brushed Steel	WFGP8BS
Flat Plate 12 Gang (4 x 3) Grid Plate	
Polished Steel	WFGP12PS
Brushed Steel	WFGP12BS



WFGP1PS



WFGP2BS

Grid Frames

Description	Cat ref.
Frames for White Moulded and Decorative Raised Plate ranges	
1 Gang Frame	WMGF1
2 Gang Frame	WMGF2
3/4 Gang Frame	WMGF34
Frames for Decorative Flat Plate ranges	
1 Gang Frame	WFGF1
2 Gang Frame	WFGF2
3/4 Gang Frame	WFGF34



WMGF34



WMGKS



WMGB1



WMINDRED



WMGSDP2/CHD



WMGSDP2/EF

Grid Switches - White Moulded Finish

Characteristics:

- Complies with BS EN 60669-1:2018 switches, BS 5733 fuse carrier.
- Shallowest switch modules which clip in from the front for ease of installation and maintenance.
- Terminal screw can be accessed with modules clipped into frames.
- Frames locate to finished wall level.
- Frames clip together to ease alignment for 6 gang and 8 gang applications.
- 20A Switches suitable for SBL circuits to a maximum of 250W SBL
- We also offer a bespoke printing service for your individual requirements. Please contact our Sales Service Centre on 01952 675612 for further details.

Description	Cat ref. White Insert	Cat ref. Black Insert
Grid Switches		
Blank Module	WMGB1	-
20AX 2 Way Single Pole Switch	WMGS12	-
20A Intermediate Switch	WMGS16	-
20A 2 Way Retractive Switch	WMGS22R	-
20A 1 Way Double Pole Switch	WMGSDP2	-
20A 1 Way Double Pole Switch with LED Indicator	WMGSDP2N	-
20A Double Pole Key Switch	WMGKS	-
20A Double Pole Key Switch Printed 'Emergency Lighting Test'	WMGKS/EL	-
13A Fuse Carrier	WMGFU13	-
Dimmer Slave Switch	WMGSD1S	WMGSD1SB
Dimmer Switch Leading Edge	WMGSD1L	WMGSD1LB
Dimmer Switch Trailing Edge	WMGSD1T	WMGSD1TB
Red Indicator	WMINDRED	WMINDREDB
2 Way & Centre Off Latching Switch	WMGS13L	WMGS13LB
2 Way & Centre Off Latching Switch Red Rocker	WMGS13LR	-
2 Way & Centre Off Retractive Switch	WMGS13R	WMGS13RB
2 Way & Centre Off Retractive Switch Red Rocker	WMGS13RR	-
13A Fused Connection Unit Unswitched with LED	WMGSU83N	-
20A 1 Way Double Pole Grid Switches - Printed		
Printed 'Boiler'	WMGSDP2/BOI	-
Printed 'Cooker Hood'	WMGSDP2/CHD	WMGSDP2B/CHD
Printed 'Dishwasher'	WMGSDP2/DW	WMGSDP2B/DW
Printed 'Extract Fan'	WMGSDP2/EF	WMGSDP2B/EF
Printed 'Fridge Freezer'	WMGSDP2/FF	WMGSDP2B/FF
Printed 'Freezer'	WMGSDP2/FRE	WMGSDP2B/FRE
Printed 'Fridge'	WMGSDP2/FRI	WMGSDP2B/FRI
Printed 'Hob'	WMGSDP2/HB	WMGSDP2B/HB
Printed 'Heating'	WMGSDP2/HTG	WMGSDP2B/HTG
Printed 'Microwave'	WMGSDP2/MW	WMGSDP2B/MW
Printed 'Micro Wave'	WMGSDP2MW2	-
Printed 'Tumble Dryer'	WMGSDP2/TD	WMGSDP2B/TD
Printed 'Waste Disposal'	WMGSDP2/WD	WMGSDP2B/WD
Printed 'Washing Machine'	WMGSDP2/WM	WMGSDP2B/WM
Printed 'Oven'	WMGSDP2/OV	WMGSDP2B/OV
Printed 'Wine Cooler'	WMGSDP2/WC	WMGSDP2B/WC
Printed 'Hot Water'	WMGSDP2/HW	WMGSDP2B/HW
Printed 'Coffee Maker'	WMGSDP2/CM	WMGSDP2B/CM
Printed 'Hot Drawer'	WMGSDP2/HD	WMGSDP2B/HD
Printed 'Fan Boost'	WMGSDP2/FB	WMGSDP2B/FB
Printed 'Outside Light'	WMGSDP2/OL	-
Printed 'Outside Socket'	WMGSDP2/OS	-
Printed 'Plinth Heater'	WMGSDP2/PH	-

Grid Switches - Printed

Characteristics:

- Complies with BS EN 606691-1 switches, BS 5733 fuse carrier.
- Shallowest switch modules which clip in from the front for ease of installation and maintenance.
- Terminal screw can be accessed with modules clipped into frames.
- Frames locate to finished wall level.
- Frames clip together to ease alignment for 6 gang and 8 gang applications.
- We also offer a bespoke printing service for your individual requirements. Please contact our Sales Service Centre on 01952 675612 for further details.

Description	Cat ref. White Insert	Cat ref. Black Insert
20A 1 Way Double Pole Grid Switches with LED Indicator - Printed		
Printed 'Cooker Hood'	WMGSDP2N/CHD	WMGSDP2NB/CHD
Printed 'Dishwasher'	WMGSDP2N/DW	WMGSDP2NB/DW
Printed 'Extract Fan'	WMGSDP2N/EF	WMGSDP2NB/EF
Printed 'Fridge Freezer'	WMGSDP2N/FF	WMGSDP2NB/FF
Printed 'Freezer'	WMGSDP2N/FRE	WMGSDP2NB/FRE
Printed 'Fridge'	WMGSDP2N/FRI	WMGSDP2NB/FRI
Printed 'Hob'	WMGSDP2N/HB	WMGSDP2NB/HB
Printed 'Heating'	WMGSDP2N/HTG	WMGSDP2NB/HTG
Printed 'Microwave'	WMGSDP2N/MW	WMGSDP2NB/MW
Printed 'Tumble Dryer'	WMGSDP2N/TD	WMGSDP2NB/TD
Printed 'Waste Disposal'	WMGSDP2N/WD	WMGSDP2NB/WD
Printed 'Washing Machine'	WMGSDP2N/WM	WMGSDP2NB/WM
Printed 'Oven'	WMGSDP2N/OV	-
Printed 'Outside Light'	WMGSDP2N/OL	-
Printed 'Outside Socket'	WMGSDP2N/OS	-
Printed 'Plinth Heater'	WMGSDP2N/PH	-



WMGSDP2N/CHD



WMGSDP2N/DW



WMGSDP2N/EF



WMGSDP2N/FF



WMGB1BSW



WMGS12PSB



WMGB1BSB



WMGB1BSW

Grid Switches - Decorative Finish

Characteristics:

- Complies with BS EN 60669-1:2018 switches, BS 5733 fuse carrier.
- Shallowest switch modules for ease of installation.
- Modules clip from the front for ease of installation and maintenance.
- Terminal screw can be accessed with modules clipped into frames.
- Frames locate to finished wall level.
- Frames clip to ease alignment for 6 gang and 8 gang applications.
- 20A Switches suitable for SBL circuits to a maximum of 250W SBL

Description	Cat ref. White Insert	Cat ref. Black Insert
20AX 2 Way Single Pole Switch		
Polished Steel	WMGS12PSW	WMGS12PSB
Brushed Steel	WMGS12BSW	WMGS12BSB
20A Intermediate Switch		
Polished Steel	WMGS16PSW	WMGS16PSB
Brushed Steel	WMGS16BSW	WMGS16BSB
20A 2 Way Retractive Switch		
Polished Steel	WMGS22RPSW	WMGS22RPSB
Brushed Steel	WMGS22RBSW	WMGS22RBSB
20A 1 Way Double Pole Switch		
Polished Steel	WMGSDP2PSW	WMGSDP2PSB
Brushed Steel	WMGSDP2BSW	WMGSDP2BSB
13A Fuse Carrier		
Polished Steel	WMGFU13PSW	WMGFU13PSB
Brushed Steel	WMGFU13BSW	WMGFU13BSB
Blank Module		
Polished Steel	WMGB1PSW	WMGB1PSB
Brushed Steel	WMGB1BSW	WMGB1BSB

Blank Plates Raised Plate

Characteristics:

- WR references supplied with M3.5 x 30mm long fixing screws.
- WF references supplied with M3.5 x 20mm long fixing screws.

Description	Cat ref.
Raised Plate Switch Blank Plate	
Polished Steel	WRP1PS
Brushed Steel	WRP1BS



WRP2PS

Raised Plate Twin Blank Plate

Polished Steel	WRP2PS
Brushed Steel	WRP2BS

Blank Plates Flat Plate

Description	Cat ref.
Flat Plate Switch Blank Plate	
Polished Steel	WFP1PS
Brushed Steel	WFP1BS



WFP1BS

Flat Plate Twin Blank Plate

Polished Steel	WFP2PS
Brushed Steel	WFP2BS



WPPS12W



WPPS12



Metalclad Wall Switches (10A)

Characteristics:

- Unique patented LOOP terminal to allow neutral looping at the switch.
- Complies with BS EN 60669-1:2018, a.c only.
- 'X' rated - No need to de-rate for fluorescent loads.
- Capacity of each terminal 2 x 4.0mm² conductors.
- 10A Switches suitable for SBL circuits to a maximum of 100W SBL.

Description	Cat ref. Plate Only	Cat ref. With Backbox Without Knockouts	Cat ref. With Backbox With Knockouts
Wall Switches White			
10AX 1 Gang 2 Way Wall Switch	WPPS12W	-	-
10AX 2 Gang 2 Way Wall Switch	WPPS22W	-	-
10AX 3 Gang 2 Way Wall Switch	WPPS32W	-	-
10AX Push Switch	WPPS12RW	-	-

Wall Switches Grey

10AX 1 Gang 2 Way Wall Switch	WPPS12	WPPS12B	WPPS12BKO
10AX 2 Gang 2 Way Wall Switch	WPPS22	WPPS22B	WPPS22BKO
10AX 3 Gang 2 Way Wall Switch	WPPS32	WPPS32B	WPPS32BKO
10AX Push Switch	WPPS12R	WPPS12RB	WPPS12RBKO

Metalclad Wall Switches (20A)

Characteristics:

- Unique patented LOOP terminal to allow neutral looping at the switch.
- Complies with BS EN 60669-1, a.c only.
- Capacity of each terminal 2 x 6.0mm² conductors.
- Single screw fast fix cable clamp accommodates up to 2.5mm² flexible cord.



WPDP84FO

Description	Cat ref. Plate Only	Cat ref. With Backbox Without Knockouts	Cat ref. With Backbox With Knockouts
Wall Switches White			
20A Double Pole Switch with Flex Outlet	WPDP84FOW	-	-
20A Double Pole Switch with LED Indicator & Flex Outlet	WPDP84FONW	-	-
Wall Switches Grey			
20A Double Pole Switch with Flex Outlet	WPDP84FO	WPDP84FOB	WPDP84FOBKO
20A Double Pole Switch with LED Indicator & Flex Outlet	WPDP84FON	WPDP84FONB	WPDP84FONBKO



WPDP50N

Metalclad Wall Switches (50A)

Characteristics:

- Unique patented LOOP terminal to allow neutral looping at the switch.
- Complies with BS EN 60669-2-4.
- Capacity of each terminal 2 x 6.0mm² conductors.

Description	Cat ref. Plate Only	Cat ref. With Backbox Without Knockouts	Cat ref. With Backbox With Knockouts
Wall Switches White			
50A Double Pole Switch 1 Gang with LED Indicator	WPDP50NW	-	-
Wall Switches Grey			
50A Double Pole Switch 1 Gang with LED Indicator	WPDP50N	WPDP50NB	WPDP50NBKO

Metalclad Socket Outlets

Characteristics:

- Unique patented three part safety shutter.
- Complies with BS 1363-2, a.c only.
- Double pole switching mechanism on switched sockets.
- Twin socket comes with twin earth as standard.
- Terminal screws grouped in-line and upward facing for ease of installation with clear printed and engraved terminal markings.
- Capacity of each terminal: 5 x 2.5mm² conductors switched; 4 x 2.5mm² unswitched (for other sized conductors see terminal capacities on page 59).
- **Sockets with USB - Warning:** To avoid possible damage to the product or spurious insulation readings, please disconnect the product before carrying out insulation resistance testing.
- **Sockets with USB** - USB output: 5V d.c. 3.1A total max.



WPSS81W

Description	Cat ref. Plate Only	Cat ref. With Backbox Without Knockouts	Cat ref. With Backbox With Knockouts
Switched Socket Outlets White			
1 Gang Double Pole Switched Socket	WPSS81W	-	-
1 Gang Double Pole Switched Socket with LED Indicator	WPSS81NW	-	-
2 Gang Double Pole Switched Socket	WPSS82W	-	-
2 Gang Double Pole Switched Socket with LED Indicator	WPSS82NW	-	-
2 Gang Double Pole Switched Socket Outboard Rockers	WPSS82OW	-	-
2 Gang Double Pole Switched Socket with Two USB Ports (Type A+A)	WPSS82W-USB	-	-
2 Gang Double Pole Switched Socket with Two USB Ports (Type A+C)	WPSS82W-USBAC	-	-



WPSS81

Switched Socket Outlets Grey			
1 Gang Double Pole Switched Socket	WPSS81	WPSS81B	WPSS81BKO
1 Gang Double Pole Switched Socket with LED Indicator	WPSS81N	WPSS81NB	WPSS81NBKO
2 Gang Double Pole Switched Socket	WPSS82	WPSS82B	WPSS82BKO
2 Gang Double Pole Switched Socket with LED Indicator	WPSS82N	WPSS82NB	WPSS82NBKO
2 Gang Double Pole Switched Socket Outboard Rockers	WPSS82O	WPSS82OB	WPSS82OBKO
2 Gang Double Pole Switched Socket with Two USB Ports (Type A+A)	WPSS82-USB	WPSS82B-USB	WPSS82BKO-USB
2 Gang Double Pole Switched Socket with Two USB Ports (Type A+C)	WPSS82-USBAC	WPSS82B-USBAC	WPSS82BKO-USBAC



WPSS82W-USB

Metalclad Fuse Connection Units

Characteristics:

- Complies with BS 1363-4.
- Single screw fast fix cable clamp accommodates up to 2.5mm² flexible cord.
- All terminals are upward facing with clearly printed terminal markings for ease of installation.
- Capacity of each terminal 2 x 6.0 mm² conductors.

Note: For constant 3kW loads not requiring overload protection, consideration should be given to the use of 20A DP switches instead (page 48).

Description	Cat ref. Plate Only	Cat ref. With Backbox Without Knockouts	Cat ref. With Backbox With Knockouts
Fuse Connection Units White			
13A FCU Unswitched with Flex Outlet	WPSU83FOW	-	-
13A FCU Switched with Flex Outlet	WPSSU83FOW	-	-
13A FCU Switched with LED Indicator & Flex Outlet	WPSSU83FONW	-	-
Fuse Connection Units Grey			
13A FCU Unswitched with Flex Outlet	WPSU83FO	WPSU83FOB	WPSU83FOBKO
13A FCU Switched with Flex Outlet	WPSSU83FO	WPSSU83FOB	WPSSU83FOBKO
13A FCU Switched with LED Indicator & Flex Outlet	WPSSU83FON	WPSSU83FONB	WPSSU83FONBKO



WPSSU83FOW



WPSSU83FON



WPGP1W



WPGP1

Metalclad Grid Plates

Characteristics:

- For Grid Switches, please see page 44.

Description	Cat ref. Plate Only	Cat ref. With Backbox Without Knockouts	Cat ref. With Backbox With Knockouts
Grid Plates White			
Grid plate 1 Gang	WPGP1W	-	-
Grid plate 2 Gang	WPGP2W	-	-
Grid plate 3 Gang	WPGP3W	-	-
Grid plate 4 Gang	WPGP4W	-	-
Grid plate 6 Gang	WPGP6W	-	-
Grid plate 8 Gang	WPGP8W	-	-
Grid Plates Grey			
Grid plate 1 Gang	WPGP1	WPGP1B	WPGP1BKO
Grid plate 2 Gang	WPGP2	WPGP2B	WPGP2BKO
Grid plate 3 Gang	WPGP3	WPGP3B	WPGP3BKO
Grid plate 4 Gang	WPGP4	WPGP4B	WPGP4BKO
Grid plate 6 Gang	WPGP6	WPGP6B	WPGP6BKO
Grid plate 8 Gang	WPGP8	WPGP8B	WPGP8BKO



WMGF34

Grid Frames

Description	Cat ref.
Frames for White Moulded, Decorative & Metalclad Raised Plate ranges	
1 Gang Frame	WMGF1
2 Gang Frame	WMGF2
3/4 Gang Frame	WMGF34



WMGKS



WMGB1



WMINDRED

Grid Switches - White Moulded Finish

Characteristics:

- Complies with BS EN 60669-1:2018 switches, BS 5733 fuse carrier.
- Shallowest switch modules which clip in from the front for ease of installation and maintenance.
- Terminal screw can be accessed with modules clipped into frames.
- Frames locate to finished wall level.
- Suitable for SBL circuits to a maximum of 250 W SBL
- Frames clip together to ease alignment for 6 gang and 8 gang applications.
- We also offer a bespoke printing service for your individual requirements. Please contact our Sales Service Centre on 01952 675612 for further details.

Description	Cat ref. White Insert	Cat ref. Black Insert
Grid Switches		
Blank Module	WMGB1	-
20AX 2 Way Single Pole Switch	WMGS12	-
20A Intermediate Switch	WMGS16	-
20A 2 Way Retractive Switch	WMGS22R	-
20A 1 Way Double Pole Switch	WMGSDP2	-
20A 1 Way Double Pole Switch with LED Indicator	WMGSDP2N	-
20A Double Pole Key Switch	WMGKS	-
20A Double Pole Key Switch Printed 'Emergency Lighting Test'	WMGKS/EL	-
13A Fuse Carrier	WMGFU13	-
Dimmer Slave Switch	WMGSD1S	WMGSD1SB
Dimmer Switch Leading Edge	WMGSD1L	WMGSD1LB
Dimmer Switch Trailing Edge	WMGSD1T	WMGSD1TB
Red Indicator	WMINDRED	WMINDREDB
2 Way & Centre Off Latching Switch	WMGS13L	WMGS13LB
2 Way & Centre Off Latching Switch Red Rocker	WMGS13LR	-
2 Way & Centre Off Retractive Switch	WMGS13R	WMGS13RB
2 Way & Centre Off Retractive Switch Red Rocker	WMGS13RR	-
13A Fused Connection Unit Unswitched with LED	WMGSU83N	-

20A 1 Way Double Pole Grid Switches - Printed

Printed 'Boiler'	WMGSDP2/BOI	-
Printed 'Cooker Hood'	WMGSDP2/CHD	WMGSDP2B/CHD
Printed 'Dishwasher'	WMGSDP2/DW	WMGSDP2B/DW
Printed 'Extract Fan'	WMGSDP2/EF	WMGSDP2B/EF
Printed 'Fridge Freezer'	WMGSDP2/FF	WMGSDP2B/FF
Printed 'Freezer'	WMGSDP2/FRE	WMGSDP2B/FRE
Printed 'Fridge'	WMGSDP2/FRI	WMGSDP2B/FRI
Printed 'Hob'	WMGSDP2/HB	WMGSDP2B/HB
Printed 'Heating'	WMGSDP2/HTG	WMGSDP2B/HTG
Printed 'Microwave'	WMGSDP2/MW	WMGSDP2B/MW
Printed 'Micro Wave'	WMGSDP2MW2	-
Printed 'Tumble Dryer'	WMGSDP2/TD	WMGSDP2B/TD
Printed 'Waste Disposal'	WMGSDP2/WD	WMGSDP2B/WD
Printed 'Washing Machine'	WMGSDP2/MM	WMGSDP2B/MM
Printed 'Oven'	WMGSDP2/OV	WMGSDP2B/OV
Printed 'Wine Cooler'	WMGSDP2/WC	WMGSDP2B/WC
Printed 'Hot Water'	WMGSDP2/HW	WMGSDP2B/HW
Printed 'Coffee Maker'	WMGSDP2/CM	WMGSDP2B/CM
Printed 'Hot Drawer'	WMGSDP2/HD	WMGSDP2B/HD
Printed 'Fan Boost'	WMGSDP2/FB	WMGSDP2B/FB
Printed 'Outside Light'	WMGSDP2/OL	-
Printed 'Outside Socket'	WMGSDP2/OS	-
Printed 'Plinth Heater'	WMGSDP2/PH	-



WMGSDP2/CHD



WMGSDP2/EF

Grid Switches with LED Indicator - Printed

Characteristics:

- Complies with BS EN 60669-1:2018 switches, BS 5733 fuse carrier.
- Shallowest switch modules which clip in from the front for ease of installation and maintenance.
- Terminal screw can be accessed with modules clipped into frames.
- Frames locate to finished wall level.
- Frames clip together to ease alignment for 6 gang and 8 gang applications.
- Suitable for SBL circuits to a maximum of 250 W SBL
- We also offer a bespoke printing service for your individual requirements. Please contact our Sales Service Centre on 01952 675612 for further details.

Description	Cat ref. White Insert	Cat ref. Black Insert
20A 1 Way Double Pole Grid Switches with LED Indicator - Printed		
Printed 'Cooker Hood'	WMGSDP2N/CHD	WMGSDP2NB/CHD
Printed 'Dishwasher'	WMGSDP2N/DW	WMGSDP2NB/DW
Printed 'Extract Fan'	WMGSDP2N/EF	WMGSDP2NB/EF
Printed 'Fridge Freezer'	WMGSDP2N/FF	WMGSDP2NB/FF
Printed 'Freezer'	WMGSDP2N/FRE	WMGSDP2NB/FRE
Printed 'Fridge'	WMGSDP2N/FRI	WMGSDP2NB/FRI
Printed 'Hob'	WMGSDP2N/HB	WMGSDP2NB/HB
Printed 'Heating'	WMGSDP2N/HTG	WMGSDP2NB/HTG
Printed 'Microwave'	WMGSDP2N/MW	WMGSDP2NB/MW
Printed 'Tumble Dryer'	WMGSDP2N/TD	WMGSDP2NB/TD
Printed 'Waste Disposal'	WMGSDP2N/WD	WMGSDP2NB/WD
Printed 'Washing Machine'	WMGSDP2N/MM	WMGSDP2NB/MM
Printed 'Oven'	WMGSDP2N/OV	-
Printed 'Outside Light'	WMGSDP2N/OL	-
Printed 'Outside Socket'	WMGSDP2N/OS	-
Printed 'Plinth Heater'	WMGSDP2N/PH	-



WMGSDP2N/CHD



WMGSDP2N/DW



WMGSDP2N/EF



WPP1EUW



WPP1EU

Metalclad Euro Plates

Characteristics:

- Carrier plates facilitate installation of industry standard modular data outlets.
- Easy to configure for all applications.
- Quick release of modules for maintenance.
- Available as plate only for installation with standard wall box.

Description	Cat ref. Plate Only	Cat ref. With Backbox Without Knockouts	Cat ref. With Backbox With Knockouts
Euro Plates White			
1 Module Euro Plate	WPP1EUW	-	-
2 Module Euro Plate	WPP2EUW	-	-
4 Module Euro Plate	WPP4EUW	-	-
Euro Plates Grey			
1 Module Euro Plate	WPP1EU	WPP1EUB	WPP1EUBKO
2 Module Euro Plate	WPP2EU	WPP2EUB	WPP2EUBKO
4 Module Euro Plate	WPP4EU	WPP4EUB	WPP4EUBKO



WMMBTM

WMMSAT



WMMQXB

Euro Style Modules

Description	Mod Width	Cat ref. (White)	Cat ref. (Black)
BT Telephone Master Euromodule	1	WMMBTM	WMMBTMB
BT Telephone Secondary Euromodule	1	WMMBTS	WMMBTSB
RJ11 - Modem Euromodule	1	WMMRJ11	WMMRJ11B
RJ45 - Cat 6 UTP Euromodule	1	WMMRJ45	WMMRJ45B
Phono Plugs - Red/Black - Gold Plated Euromodule	1	WMMPP	-
Speaker Terminal Posts - Gold Plated Euromodule	1	WMMSP	-
Single IEC Female Non Isolated Euromodule	1	WMMTVF	WMMTVFB
Single IEC Male Non Isolated Euromodule	1	WMMTVM	WMMTVMB
Single Satellite F Connector Euromodule	1	WMMSAT	WMMSATB
Single Blank Euromodule	1	WMMB	WMMBB
PIR Occupancy Sensor Euromodule 5m	1	WMMPIR05X	-
PIR Occupancy Sensor Euromodule 10m	1	WMMPIR10X	-
HDMI Module	2	WMMHDMI	WMMHDMIB
Triplexer - TV, Satellite & FM Radio Euromodule	2	WMMTX	WMMTXB
Quadplexer - TV, Satellite, FM Radio & Return Euromodule	2	WMMQX	WMMQXB

Metalclad Back Boxes

Description	Cat ref. With Backbox Without Knockouts	Cat ref. With Backbox With Knockouts
Accessories White		
Single Backbox	WPB140W	WPB140KOW
Twin Backbox	WPB240W	WPB240KOW
Two Row Twin Backbox	WPB6840W	WPB6840KOW
Accessories Grey		
Single Backbox	WPB140	WPB140KO
Twin Backbox	WPB240	WPB240KO
Two Row Twin Backbox	WPB6840	WPB6840KO



WPB140W



WPB140KO

Metalclad Blank Plates

Description	Cat ref. Plate Only	Cat ref. With Backbox Without Knockouts	Cat ref. With Backbox With Knockouts
Blank Plates White			
Single Blank Plate	WPP1W	-	-
Twin Blank Plate	WPP2W	-	-
Blank Plates Grey			
Single Blank Plate	WPP1	WPP1B	WPP1BKO
Twin Blank Plate	WPP2	WPP2B	WPP2BKO



WPP1W



WPP1



WXPPS12

Wall Switches

Characteristics:

- IP66 rating conforms to BS EN 60529 : 1992.
- Functional products tested and certified to BS EN 60669-1:2018, a.c. only.
- Robust and rugged enclosures designed to withstand the elements.
- Suitable for SBL circuits to a maximum of 100 W SBL for 10A and 250W SBL for 20AX
- Cable entries: 90 x 90 = 4x20, 1x20 & 1x25

Description	Dimensions (mm)	
	(W x H)	Cat ref.
10AX 1 Gang 2 Way Switch	90 x 90	WXPPS12
10AX 2 Gang 2 Way Switch	90 x 90	WXPPS22
20AX Double Pole 1 Gang 1 Way Switch	90 x 90	WXPPD84
10A 1 Gang Bell Push Switch	90 x 90	WXPPS12B



WXPSS82

Socket Outlets

Characteristics:

- IP66 rating conforms to BS EN 60529 : 1992.
- Functional products tested and certified to BS 1363 Part 2, a.c. only.
- Robust and rugged enclosures designed to withstand the elements.
- Unique double hinge allows lid to open a full 180 degrees.
- Fixing point for padlock.
- Cable entries: 103 x 116.5 = 4x20, 1x20 & 1x25
164 x 116.5 = 6x20, 1x20 & 1x25

Description	Dimensions (mm)	
	(W x H)	Cat ref.
13A 1 Gang Double Pole Unswitched Socket	103 x 116.5	WXPS81
13A 1 Gang Double Pole Switched Socket	103 x 116.5	WXPSS81
13A 2 Gang Double Pole Unswitched Socket	164 x 116.5	WXPS82
13A 2 Gang Double Pole Switched Socket	164 x 116.5	WXPSS82



WXPSSU83FO

Fused Connection Units

Characteristics:

- IP66 rating conforms to BS EN 60529 : 1992.
- Functional products tested and certified to BS 1363-4.
- Robust and rugged enclosures designed to withstand the elements.
- Unique double hinge allows lid to open a full 180 degrees.
- Single screw fast fix cable clamp, accommodates up to 2.5mm² flexible cord.
- Fixing point for padlock.
- Cable entries: 103 x 116.5 = 4x20, 1x20 & 1x25

Description	Dimensions (mm)	
	(W x H)	Cat ref.
13A Double Pole Fused Connect Unit with Flex Outlet	103 x 116.5	WXPSSU83FO



WXPSS81EV

Electric Vehicle Socket Outlet

Characteristics:

- IP66 rating conforms to BS EN 60529 : 1992.
- Functional products tested and certified to BS 1363 Part 2, a.c. only.
- Robust and rugged enclosures designed to withstand the elements.
- Unique double hinge allows lid to open a full 180 degrees.
- Fixing point for padlock.
- Cable entries: 103 x 116.5 = 4x20, 1x20 & 1x25

Description	Dimensions (mm)	
	(W x H)	Cat ref.
13A 1 Gang Double Pole Switched Socket	103 x 116.5	WXPSS81EV

Maintenance Free Junction Box

Characteristics:

- Complies with BS EN 60670-22.
- Suitable for use in inaccessible areas.
- Spring fit terminals do not relax over time.
- Four separate cable terminations per connector.
- Comes complete with incoming and outgoing cable clamps.
- Junction box selection chart see page 61.



J804

Description	Terminal capacity	Pack qty.	Cat ref.
Maintenance Free 32A - 3 Terminals	4 x 4mm ² x (0.5 - 4.0)	10	J803
Maintenance Free 20A - 4 Terminals	4 x 4mm ² x (0.5 - 4.0)	10	J804

Downlighter Junction Box

Characteristics:

- Comes complete with incoming and outgoing cable clamps to prevent strain on terminations.
- Three plate terminals with separate terminals for flexible cords.
- Complies with BS EN 60670-22.
- Fits through a 58mm diameter hole.
- 3 plate terminal style with captive terminal screws.
- Separate terminals for flexible cords.
- Current rating: 16 Amp.
- Junction box selection chart see page 61.

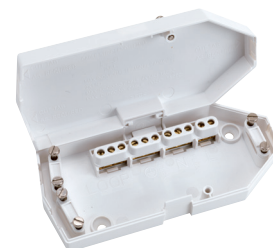

J501

Description	Terminal capacity	Pack qty.	Cat ref.
Downlighter Junction Box	3 x (3 x 1.5mm ²) 1 x (2 x 1.5mm ²)	10	J501

Traditional Junction Box

Characteristics:

- Complies with BS EN 60670-22.
- Slot terminals are ideal for taking spurs off uncut ring or loop circuit cables.
- Solid machined brass terminals.
- Junction box covers secured by single centre screws.
- Junction box selection chart see page 61.



J201

Description	Terminal capacity (mm ²)	Pack qty.	Cat ref.
Knockout Slot Terminal Junction Box 20A 4 Terminal	3 x 1.5	10	J201
Selective Entry Slot Terminal Junction Box 20A 4 Terminal	3 x 1.5	10	J301
Selective Entry Slot Terminal Junction Box 30A 3 Terminal	4 x 2.5	10	J401
Selective Entry Slot Terminal Junction Box 20A 6 Terminal	3 x 1.5	10	J601

Junction / Adaptable Box

Characteristics:

- Junction box cover secured by two screws
- Accepts 16mm x 16mm and /or 16mm x 25mm mini-trunking.
- Junction box selection chart see page 61.

Description	Terminal capacity	Pack qty.	Cat ref.
No Terminals	-	10	J701



SEL212

Safety Lampholders

Characteristics:

- Complies with BS EN 7895.
- T2 heat resistance rating: 210°C.
- Automatically disconnect power at the contacts when the lamp is removed.
- 50.8mm fixing centres for non-access versions. Use with mounting blocks **MB326E/MT**.
- Body angle of angled battens set at 30°.
- Access lampholders have integral **RL624** ceiling rose base and heat resisting PVC tails.

Description	Pack qty.	Cat ref.
Safety Bayonet Cap Cord Grip Lampholders		
Cord Grip Lampholders - Short Skirt	20	SEL212



SEL354

Safety Straight Batten Lampholders

Three Terminal - Home Office Shield	20	SEL354
-------------------------------------	----	---------------

Safety Access Batten Lampholders

Straight 2 Terminal Body, 3 Terminal and Earth Base - Home Office Shield	10	SEL96T
Angled 2 Terminal Body, 3 Terminal and Earth Base - Home Office Shield	10	SEL106T

Safety Access Batten Lampholder with Safety Cover

Batten Lampholder with Safety Cover	10	SEL96TSC
-------------------------------------	----	-----------------



SEL96T



624SEL212/6

Safety Pendants Sets with Access Ceiling Rose

Characteristics:

- Pendant set complies with BS EN 60598-1.
- Capacity of each terminal: 3 x 1.00mm² conductor.
- Barriers between terminals.
- Flexible pendant cord restraining hooks.
- Fixing centres 50.8mm.
- Feet on base to aid mounting on uneven surfaces.
- Three separate knockouts accept 1, 2 or 3 x 1.5mm² conductors.
- Optional halo **RL602**.

Description	Pack qty.	Cat ref.
Safety Pendants Sets with Access Ceiling Rose		
Pendant Set 6" - Short Skirt	10	624SEL212/6
Pendant Set 9" - Short Skirt	10	624SEL212/9
Pendant Set 12" - Short Skirt	10	624SEL212/12
Pendant Set with Access Ceiling Rose with Safety Cover		
Pendant Set 6" with Safety Cover	10	624SEL212SC6

Super Access Terminal Bank Type Ceiling Rose

Characteristics:

- Capacity of each terminal: 3 x 1.00mm² conductor
- Common base with 'access' batten lampholders.
- Barriers between terminals.
- Flexible pendant cord restraining hooks.
- Fixing centres 50.8mm.
- Feet on base to aid mounting on uneven surfaces.
- Three separate knockouts accept 1, 2 or 3 x 1.5mm² conductors.
- Optional halo **RL602** (see below)

Description	Dimensions	Pack qty.	Cat ref.
Three Terminals	81 Diameter x 26 (halo = 108mm diameter)	10	RL624

Mounting Blocks

Characteristics:

- Capacity of earth terminal for mounting blocks: 3 x 1.5mm².
- Cable knockout entries: **MB326E/MT** - centrally in base. Four on periphery will accept 16mm x 16mm or 16mm x 25mm mini trunking.

Description	Dimensions	Pack qty.	Cat ref.
Round Mounting Box with Earth Terminal	81 x 19	20	MB326E/MT
Round Surface Box 30mm Deep	84 x 30	10	MB2



MB326E/MT

Lampholder Skirts

Characteristics:

- Suitable for use with any lampholder or batten lampholder.

Description	Pack qty.	Cat ref.
Short Skirt	50	HAL70
Home Office Shield	50	HAL72

Halo

Description	Pack qty.	Cat ref.
Halo (108mm Diameter)	20	RL602

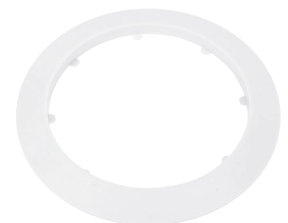

RL602

Product Reference	Product Description	Standard Surface Box Reference	Deep Surface Box Reference
WMBTM	BT Master Telephone Outlet	WMPB1/28	WMPB1/46
WMBTS	BT Secondary Telephone Outlet	WMPB1/28	WMPB1/46
WMCC50	50A Cooker Control Unit	WMPB2/46CC	N/A
WMCC50N	50A Cooker Control Unit with LED Indicator	WMPB2/46CC	N/A
WMDP50N	50A Double Pole Switch 1 Gang with LED Indicator	WMPB1/46	N/A
WMDP50VN	50A Double Pole Switch 2 Gang Vertical with LED Indicator	WMPB2/46	N/A
WMDP84	20A Double Pole Switch	WMPB1/28	WMPB1/46
WMDP84FO	20A Double Pole Switch with Flex Outlet	WMPB1/28	WMPB1/46
WMDP84FON	20A Double Pole Switch with LED Indicator & Flex Outlet	WMPB1/28	WMPB1/46
WMDP84N	20A Double Pole Switch with LED Indicator	WMPB1/28	WMPB1/46
WMDP85FON	20A Double Pole Switch with LED Indicator & Flex Outlet Printed Water Heater	WMPB1/28	WMPB1/46
WMDP85N	20A Double Pole Switch with LED Indicator Printed Water Heater	WMPB1/28	WMPB1/46
WMDS1	1 Gang Dimmer	WMPB1/28	WMPB1/46
WMDS2	2 Gang Dimmer	WMPB1/28	WMPB1/46
WMDS3	3 Gang Dimmer	WMPB2/28	WMPB2/46
WMDS4	4 Gang Dimmer	WMPB2/28	WMPB2/46
WMDX	Double TV & FM/DAB CO-AX Socket Outlet	WMPB1/28	WMPB1/46
WMP1	Single Blank Plate	WMPB1/20	WMPB1/28
WMP2	Twin Blank Plate	WMPB2/28	N/A
WMP2FO	Flex Outlet Plate 20A	WMPB1/20	WMPB1/28
WMP50FO	Cooker Cable Outlet with Terminals	WMPB1/46	N/A
WMPS11	10AX 1 Gang 1 Way Wall Switch	WMPB1/20	WMPB1/28
WMPS12	10AX 1 Gang 2 Way Wall Switch	WMPB1/20	WMPB1/28
WMPS12R	Push Switch	WMPB1/20	WMPB1/28
WMPS12RB	Push Switch with Bell Symbol	WMPB1/20	WMPB1/28
WMPS12W	10AX 1 Gang 2 Way Wall Switch Wide Rocker	WMPB1/20	WMPB1/28
WMPS16	Intermediate Switch	WMPB1/20	WMPB1/28
WMPS22	10AX 2 Gang 2 Way Wall Switch	WMPB1/20	WMPB1/28
WMPS22W	10AX 2 Gang 2 Way Wall Switch Wide Rocker	WMPB1/20	WMPB1/28
WMPS32	10AX 3 Gang 2 Way Wall Switch	WMPB1/20	WMPB1/28
WMPS3PI	3 Pole Isolator Switch	WMPB1/20	WMPB1/28
WMPS3PIF	3 Pole Isolator Switch with Fan Symbol	WMPB1/20	WMPB1/28
WMPS42	10AX 4 Gang 2 Way Wall Switch	WMPB2/28	WMPB2/28
WMQX	Quadplexer TV & FM/DAB & SAT1 & SAT2	WMPB1/28	WMPB1/46
WMRJ11	RJ11 Socket	WMPB1/28	WMPB1/46
WMRJ45	RJ45 Socket	WMPB1/28	WMPB1/46
WMS51	5A 1 Gang Unswitched Socket	WMPB1/28	WMPB1/46
WMS81	13A 1 Gang Unswitched Socket	WMPB1/28	WMPB1/46
WMS82	13A 2 Gang Unswitched Socket Dual Earth	WMPB2/28	WMPB2/46
WMSAT	Single F Type Satellite Outlet Screened	WMPB1/28	WMPB1/46
WMSO100	115/230V Shaver Outlet	WMPB2/46	N/A
WMSS81	1 Gang Double Pole Switched Socket	WMPB1/28	WMPB1/46
WMSS82	2 Gang Double Pole Switched Socket Dual Earth	WMPB2/28	WMPB2/46
WMSS82O	2 Gang Double Pole Switched Outlet Outboard Rockers	WMPB2/28	WMPB2/46
WMSSU83	13A Fused Connection Unit Switched	WMPB1/28	WMPB1/46
WMSSU83FO	13A Fused Connection Unit Switched with Flex Outlet	WMPB1/28	WMPB1/46
WMSSU83FON	13A Fused Connection Unit Switched with LED Indicator & Flex Outlet	WMPB1/28	WMPB1/46
WMSSU83N	13A Fused Connection Unit Switched with LED Indicator	WMPB1/28	WMPB1/46
WMSU83	13A Fused Connection Unit Unswitched	WMPB1/28	WMPB1/46
WMSU83FO	13A Fused Connection Unit Unswitched with Flex Outlet	WMPB1/28	WMPB1/46
WMTVF	Single CO-AX TV Socket Outlet Female	WMPB1/28	WMPB1/46
WMTVM	Single CO-AX TV Socket Outlet Male	WMPB1/28	WMPB1/46
WMTX	TriplexerTV & FM/DAB & SAT Outlet	WMPB1/28	WMPB1/46

Accessory Type	Rating	Maximum number of conductors per terminal (Solid or Stranded conductors BS 6004)						
		1.0 mm ²	1.5 mm ²	2.5 mm ²	4.0 mm ²	6.0 mm ²	10.0 mm ²	16.0 mm ²
Plate & Ceiling Accessories	10AX	4	4	3	2	-	-	-
Dimmer Switches	10AX	4	3	-	-	-	-	-
BS 546 Socket Outlet	5A	3	3	3	2	2	-	-
Shaver Socket	10A	3	2	1	-	-	-	-
Fused Connection Units	13A	-	-	3	2	2	-	-
BS 1363 Socket Outlets	13A	-	-	3	3	2	-	-
BS546 Socket Outlet	15A	-	-	3	3	2	-	-
Flex Outlet Plates	20A	5	4	3	2	2	-	-
Double Pole Switches	20A	-	-	3	2	2	1	-
Double Pole Switches	45/50A	-	-	-	3	2	1	1
Cooker Control Unit	45A	-	-	-	3	2	1	1
Cooker Connection Outlet	45A	-	-	-	2	3	-	-
Grid Switches	20AX	4	4	3	2	-	-	-

Printed Products

Many of our Sollysta wiring accessories are available with printed options, such as Washing Machine, Dishwasher etc.

For a full list of products generally available from stock please go to www.hager.co.uk/printedproducts

We also offer a bespoke printing service for your individual requirements. Please contact our Sales Service Centre on 01952 675612 for further details.

Unique Safety Shutter

Socket outlets have apertures for plug pins and therefore will have a shutter mechanism that prevents access to live parts unless the earth pin is also present and has been inserted first. This however can be either intentionally or inadvertently defeated by inserting something into the earth pin aperture.

All Sollysta sockets have a unique patented three pin shutter system that not only requires the earth pin to be inserted first, but the simultaneous insertion of the live and neutral pins as well, before the shutter mechanism is activated.

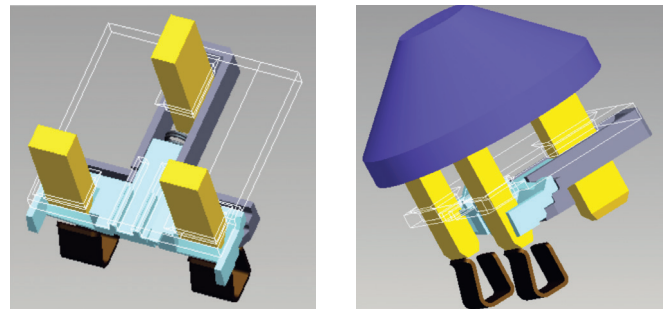

Neutral Loop Terminal

Today it is increasingly likely that there is a decorative light fitting or even downlighters fitted in place of a standard pendant. These fittings are rarely provided with a neutral loop terminal.

It has also become more popular to make the loop connection at the switch. This has the advantage of the connections being accessible and at a more convenient working height.

However, this leaves the problem of terminating the neutral conductor.

One solution is to connect the neutral to a connector block inside the wall box, which takes up extra space. Another is to use the Sollysta light switch which has a unique neutral loop terminal.

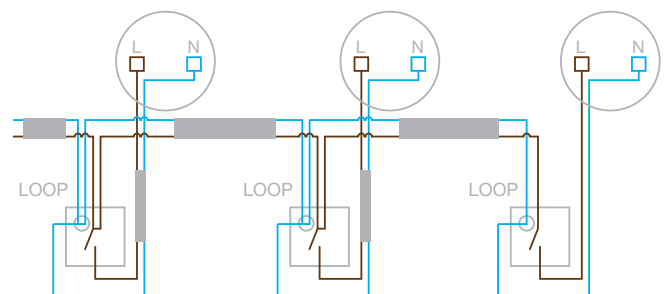

The IP rating for all low voltage enclosures up to 1000 V a.c. and 1500 V d.c. is defined in identical fashion by the standards EN 60529 - IEC 529. It comprises the letters IP followed by two character numerals and or additional/ supplementary letters.

The first character numeral indicates the degree of protection provided by the enclosure against access to hazardous parts by preventing or limiting the ingress of a part of the human body or an object held by a person and ingress of solid foreign objects.

The first character numeral:
Protection against foreign objects

IP	Description	
0		Non-protected
1		Protected against solid objects \geq than 50mm
2		Protected against solid objects \geq than 12.5mm
3		Protected against solid objects \geq than 2.5mm
4		Protected against solid objects \geq than 1.0mm
5		Dust-protected
6		Dust-tight

Additional letter (in option)
Protection of people against access to hazardous parts

	Description
A	Protected against access to hazardous parts with the back of the hand
B	Protected against access to hazardous parts with a finger
C	Protected against access to hazardous parts with a tool - ϕ 2.5mm
D	Protected against access to hazardous parts with a wire - ϕ 1mm

The second character numeral indicates the degree of protection provided by the enclosure with respect to harmful effects on the equipment due to the ingress of water. An X signifies that the tests are not applicable to the product.

The second character numeral:
Protection against ingress of water with harmful effects

IP	Description	
0		Non-protected
1		Protected against vertically falling water drops
2		Protected against vertically falling water drops when enclosure tilted up to 15°
3		Protected against spraying water
4		Protected against splashing water
5		Protected against water jets
6		Protected against powerful water jets
7		Protected against the effect of temporary immersion in water
8		Protected against continuous immersion in water

Additional letter (in option)
Specific information on the product

	Description
H	High voltage apparatus
M	Motion during water test
S	Stationary during water test
W	Weather conditions

Junction Box Selection Chart

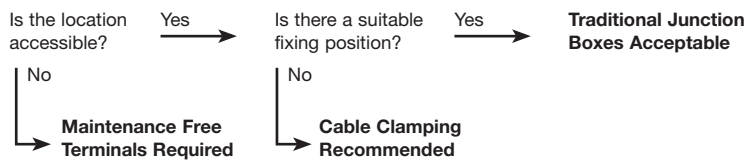

Description	N° of Terminals	Terminal Rating	Reference	Benefits / Considerations
Downlighter Junction Box	3 x 3 x 1.5mm ² 1 x 2 x 1.5mm ²	16A	J501	Provided with cable clamps and separate terminals for flex
Maintenance Free Junction Box	3 x 4 x (0.5-4.0mm ²)	32A	J803	Suitable for use in inaccessible locations
	4 x 4 x (0.5 - 4.0mm ²)	20A	J804	
Traditional Junction Boxes	4	20A	J201	Acceptable for locations which are accessible
	4	20A	J301	
	3	30A	J401	
	6	20A	J601	



Hager Ltd.

Hortonwood 50
Telford
Shropshire
TF1 7FT

Customer Services, Technical, Estimation and Debits:
01952 675675

[hager.com/uk](https://www.hager.com/uk)

sales@hager.co.uk

technical@hager.co.uk

Join our social community

 @Hager_uk

 @HagerUK

 Hager UK

 @HagerukTV

 @HagerUK